

CAP1200

User Manual

04-2015 / v1.1

Edimax Technology Co., Ltd.

No.3, Wu-Chuan 3rd Road, Wu-Gu, New Taipei City 24891, Taiwan

Email: support@edimax.com.tw

Edimax Technology Europe B.V.

Fijenhof 2, 5652 AE Eindhoven, The Netherlands

Email: support@edimax.nl

Edimax Computer Company

3350 Scott Blvd., Bldg.15 Santa Clara, CA 95054, USA

Live Tech Support: 1(800) 652-6776

Email: support@edimax.com

CONTENTS

I. Product Information.....	2
I-1. Package Contents	2
I-2. System Requirements.....	2
I-3. Hardware Overview	3
I-4. LED Status	4
I-5. Reset	5
I-6. Safety Information	6
II. Hardware Installation.....	7
II-1. Connecting the access point to a router or PoE switch.....	7
II-2. Mounting the access point to a ceiling.....	8
II-3. T-Rail Mount	11
AP Mode	
III. Quick Setup.....	13
III-1. Initial Setup	13
III-2. Basic Settings	15
IV. Browser Based Configuration Interface.....	19
IV-1. Information	21
IV-1-1. System Information	21
IV-1-2. Wireless Clients.....	25
IV-1-3. Wireless Monitor	27
IV-1-4. Log.....	29
IV-2. Network Settings	31
IV-2-1. LAN-Side IP Address.....	31
IV-2-2. LAN Port.....	33
IV-2-3. VLAN	34
IV-3. Wireless Settings.....	35
IV-3-1. 2.4GHz 11bgn.....	35
IV-3-1-1. Basic	36
IV-3-1-2. Advanced	39
IV-3-1-3. Security	41
IV-3-1-3-1. No Authentication	42
IV-3-1-3-2. WEP.....	43
IV-3-1-3-3. IEEE802.1x/EAP.....	43
IV-3-1-3-4. WPA-PSK	43

IV-3-1-3-5.	WPA-EAP	44
IV-3-1-3-6.	Additional Authentication	44
IV-3-1-4.	WDS	46
IV-3-1-5.	Schedule.....	48
	48
IV-3-2.	5GHz 11ac 11an	49
IV-3-2-1.	Basic	49
IV-3-2-2.	Advanced	51
IV-3-2-3.	Security	53
IV-3-2-4.	WDS	55
IV-3-2-5.	Schedule.....	57
IV-3-2.	WPS.....	58
IV-3-3.	RADIUS.....	60
IV-3-3-1.	RADIUS Settings	61
IV-3-3-2.	Internal Server	62
IV-3-3-3.	RADIUS Accounts	64
IV-3-4.	MAC Filter	66
IV-3-5.	WMM.....	68
IV-4.	Management	70
IV-4-1.	Admin.....	70
IV-4-2.	Date and Time.....	73
IV-4-3.	Syslog Server.....	75
IV-4-4.	Ping Test.....	76
IV-4-5.	I'm Here	77
IV-4-6.	Operation Mode	78
IV-5.	Advanced	79
IV-5-1.	LED Settings	79
IV-5-2.	Update Firmware	80
IV-5-3.	Save/Restore Settings.....	81
IV-5-4.	Factory Default	83
IV-5-5.	Reboot	84

Edimax Pro NMS

I.	Product Information.....	85
II.	Quick Setup.....	86
III.	Software Layout	92
IV.	Features.....	99

IV-1.	LOGIN, LOGOUT & RESTART	99
IV-2.	DASHBOARD	101
IV-2-1.	System Information	102
IV-2-2.	Devices Information.....	102
IV-2-3.	Managed AP.....	103
IV-2-4.	Managed AP Group.....	104
IV-2-5.	Active Clients	105
IV-3.	ZONE PLAN.....	106
IV-4.	NMS MONITOR	108
IV-4-1.	Access Point	108
IV-4-1-1.	Managed AP.....	108
IV-4-1-2.	Managed AP Group.....	110
IV-4-2.	WLAN	112
IV-4-2-1.	Active WLAN	112
IV-4-2-2.	Active WLAN Group	113
IV-4-3.	Clients	113
IV-4-3-1.	Active Clients	113
IV-4-4.	Rogue Devices.....	114
IV-4-5.	Information.....	115
IV-4-5-1.	All Events/Activities	115
IV-4-5-2.	Monitoring	116
IV-5.	NMS Settings.....	117
IV-5-1.	Access Point	117
IV-5-2.	WLAN	128
IV-5-3.	RADIUS.....	132
IV-5-4.	Access Control	138
IV-5-5.	Guest Network.....	141
IV-5-6.	Zone Edit	145
IV-5-7.	Firmware Upgrade	147
IV-5-8.	Advanced	148
IV-5-8-1.	System Security.....	148
IV-5-8-2.	Date & Time	148
IV-6.	Local Network.....	150
IV-6-1.	Network Settings	150
IV-6-1-1.	LAN-Side IP Address.....	150
IV-6-1-2.	LAN Port Settings	153
IV-6-1-3.	VLAN	154
IV-6-2.	2.4GHz 11bgn.....	155
IV-6-2-1.	Basic	155
IV-6-2-2.	Advanced	157
IV-6-2-3.	Security	159

IV-6-2-3-1.	No Authentication	160
IV-6-2-3-2.	WEP	160
IV-6-2-3-3.	IEEE802.1x/EAP	161
IV-6-2-3-4.	WPA-PSK	161
IV-6-2-3-5.	WPA-EAP	161
IV-6-2-3-6.	Additional Authentication	162
IV-6-2-4.	WDS	163
IV-6-3.	5GHz 11ac 11an	165
IV-6-3-1.	Basic	165
IV-6-3-2.	Advanced	167
IV-6-3-3.	Security	169
IV-6-3-4.	WDS	171
IV-6-4.	WPS	173
IV-6-5.	RADIUS	174
IV-6-5-1.	RADIUS Settings	175
IV-6-5-2.	Internal Server	176
IV-6-5-3.	RADIUS Accounts	178
IV-6-6.	MAC Filter	180
IV-6-7.	WMM	182
IV-7.	Local Settings	184
IV-7-1.	Operation Mode	184
IV-7-2.	Network Settings	184
IV-7-2-1.	System Information	184
IV-7-2-2.	Wireless Clients	187
IV-7-2-3.	Wireless Monitor	188
IV-7-2-4.	Log	189
IV-7-3.	Management	191
IV-7-3-1.	Admin	191
IV-7-3-2.	Date and Time	192
IV-7-3-3.	Syslog Server	194
IV-7-3-4.	I'm Here	195
IV-7-4.	Advanced	196
IV-7-4-1.	LED Settings	196
IV-7-4-2.	Update Firmware	196
IV-7-4-3.	Save/Restore Settings	198
IV-7-4-4.	Factory Default	199
IV-7-4-5.	Reboot	199
IV-8.	Toolbox	200
IV-8-1.	Network Connectivity	200
IV-8-1-1.	Ping	200
IV-8-1-2.	Trace Route	200

V. Appendix	201
V-1. Configuring your IP address.....	201
V-1-1. Windows XP	202
V-1-2. Windows Vista	204
V-1-3. Windows 7	206
V-1-4. Windows 8	210
V-1-5. Mac	214
V. Best Practice	216
VI-1. How to Create and Link WLAN & Access Point Groups.....	216

OVERVIEW

Your access point can function in three different modes.

The default mode for your access point is **AP mode**.

AP mode is a regular access point for use in your wireless network.

AP Controller mode acts as the designated master of an AP array (group of linked access points).

Managed AP mode acts as a “slave” AP within the AP array (controlled by the AP Controller “master”).

In **AP Controller** mode the user interface will switch to **Edimax Pro NMS**.

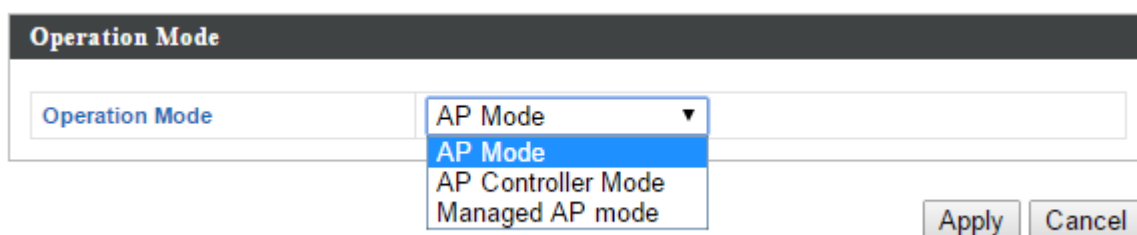

The screenshot shows a web interface for configuring the access point's operation mode. The window title is "Operation Mode". There is a text input field with the label "Operation Mode" and a dropdown menu. The dropdown menu is currently open, displaying three options: "AP Mode" (which is selected and highlighted in blue), "AP Controller Mode", and "Managed AP mode". To the right of the dropdown menu are two buttons: "Apply" and "Cancel".

This user manual is split into two parts: **AP mode** (blue) and **Edimax Pro NMS** (grey).

I. Product Information

I-1. Package Contents

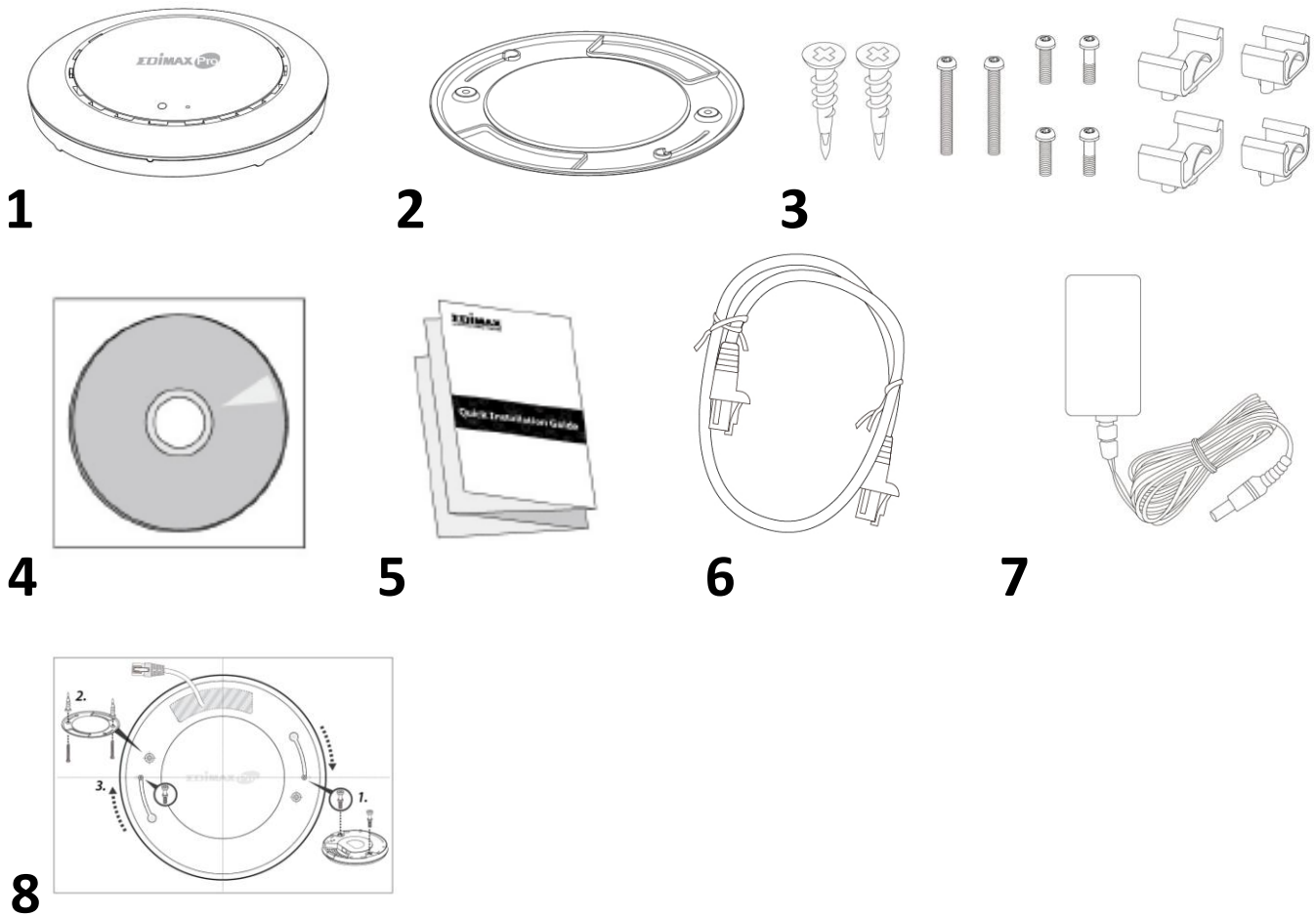

- | | |
|------------------------------------|---------------------------------|
| 1. CAP1200 Access Point | 4. CD |
| 2. Ceiling Mount Bracket | 5. Quick Installation Guide |
| 3. T-Rail Mounting Kit &
Screws | 6. Ethernet Cable |
| | 7. Power Adapter |
| | 8. Ceiling Mount Screw Template |

I-2. System Requirements

- Existing cable/DSL modem & router
- Computer with web browser for access point configuration

I-3. Hardware Overview

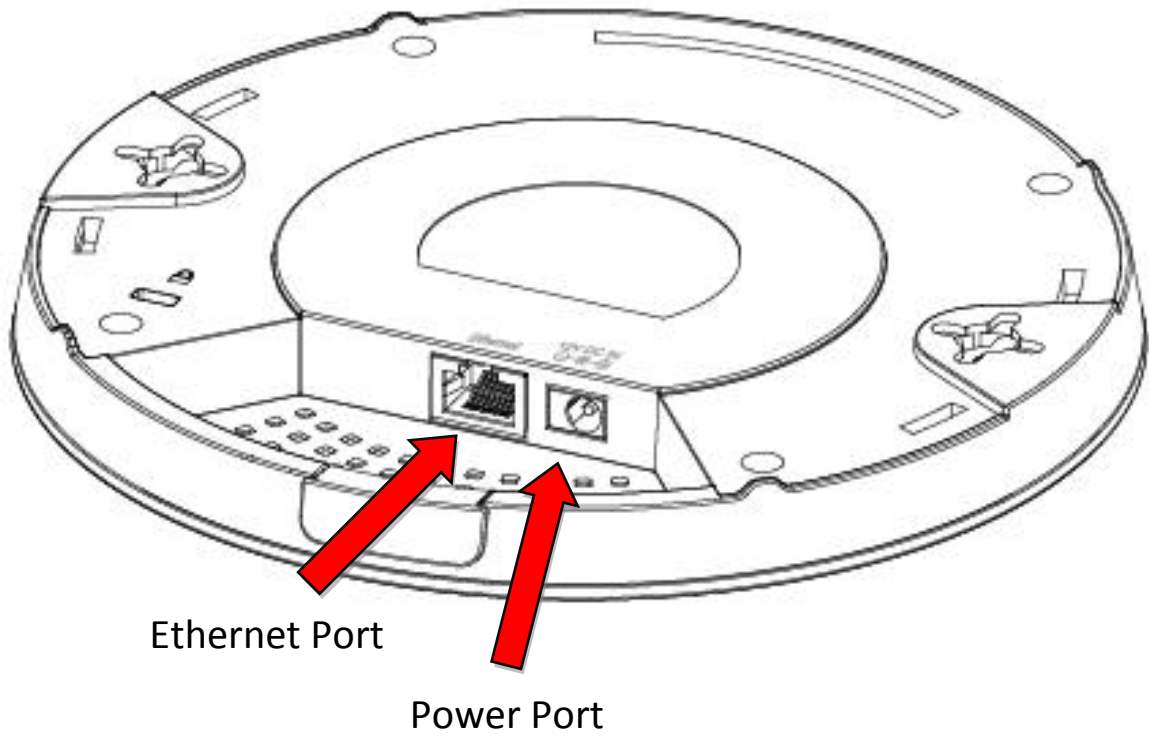

I-4. LED Status

LED Color	LED Status	Description
Blue	On	The access point is on.
	Long Flashing	Upgrading firmware.
	Short Flashing	Resetting to factory defaults.
Amber	On	Starting up.
	Flashing	Error.
Off	Off	The access point is off.

I-5. Reset

If you experience problems with your access point, you can reset the device back to its factory settings. This resets **all** settings back to default.

1. Press and hold the reset button on the access point for at least 10 seconds.



You may need to use a pin or similar sharp object to push the reset button.

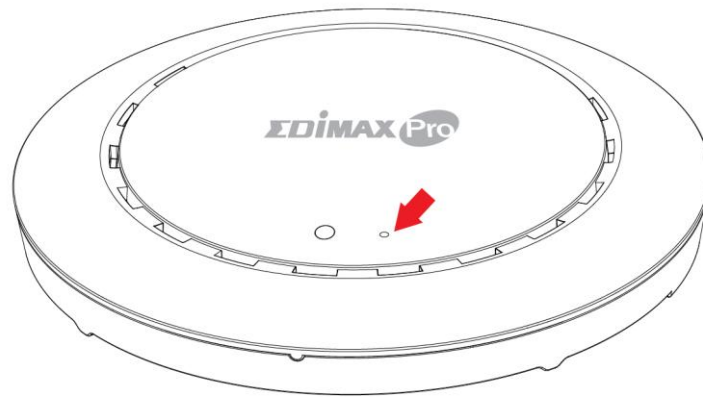

2. Wait for the access point to restart. The access point is ready for setup when the LED is **blue**.

I-6. Safety Information

In order to ensure the safe operation of the device and its users, please read and act in accordance with the following safety instructions.

1. The access point is designed for indoor use only; do not place the access point outdoors.
2. Do not place the access point in or near hot/humid places, such as a kitchen or bathroom.
3. Do not pull any connected cable with force; carefully disconnect it from the access point.
4. Handle the access point with care. Accidental damage will void the warranty of the access point.
5. The device contains small parts which are a danger to small children under 3 years old. Please keep the access point out of reach of children.
6. Do not place the access point on paper, cloth, or other flammable materials. The access point may become hot during use.
7. There are no user-serviceable parts inside the access point. If you experience problems with the access point, please contact your dealer of purchase and ask for help.
8. The access point is an electrical device and as such, if it becomes wet for any reason, do not attempt to touch it without switching the power supply off. Contact an experienced electrical technician for further help.
9. If you smell burning or see smoke coming from the access point or power adapter, then disconnect the access point and power adapter immediately, as far as it is safely possible to do so. Call your dealer of purchase for help.

II. Hardware Installation



When using the access point in AP mode it is recommended to configure some basic settings as shown in III. Quick Setup before hardware installation.

II-1. Connecting the access point to a router or PoE switch

1. If you need to, remove the cap from the underside of the access point. This creates extra space for your cables to pass through.

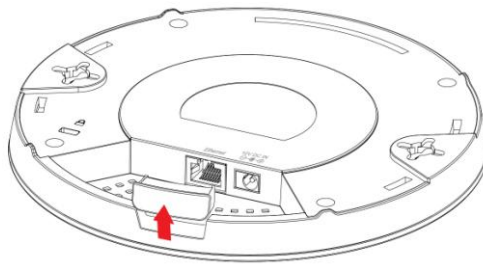

2. Connect a router or PoE switch to the access point's **LAN** port using an Ethernet cable.

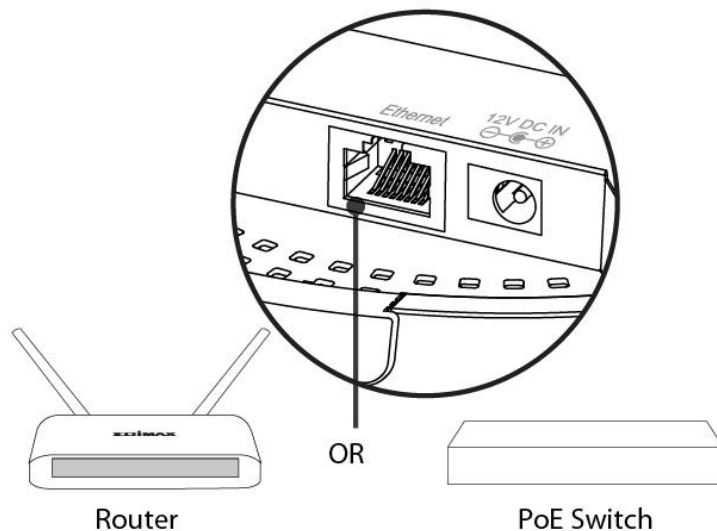

3. If you are using a router, then connect the power adapter to the access point's 12V DC port and plug the power adapter into a power supply.



Do not use the power adapter if you are using a PoE switch.

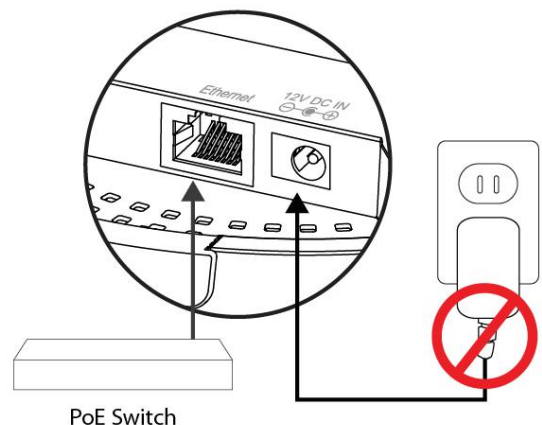

II-2. Mounting the access point to a ceiling

To mount the access point to a ceiling, please follow the instructions below and refer to diagram **A & B**.

For Wooden Ceilings (refer to diagram A):

- 1.** Place the ceiling mount bracket to a ceiling in your desired location and insert screw **iii** through hole **i** (x 2) and tighten to fix the bracket in place.
- 2.** When the ceiling bracket is in place, insert screw **iv** into hole **v** (x 2) on the access point.
- 3.** Fix the access point to the ceiling bracket by inserting the attached screws **iv** into hole **vi** and twisting the access point.
- 4.** Lock the access point firmly into place when by twisting it to align screws **iv** with the grooves in the ceiling mount.

For Other Ceilings (refer to diagram B):

- 1.** Place the ceiling mount bracket to a ceiling in your desired location and Insert screw **ii** through hole **i** (x 2) and tighten to fix the bracket in place, as shown in **A**.
- 2.** Insert screw **iii** through hole **i** and into the rear of screw **ii** and tighten to provide additional strength.
- 3.** When the ceiling bracket is in place, insert screw **iv** into hole **v** (x 2) on the access point.
- 5.** Fix the access point to the ceiling bracket by inserting the attached screws **iv** into hole **vi** and twisting the access point.
- 6.** Lock the access point firmly into place by twisting it to align screws **iv** with the grooves in the ceiling mount.

A

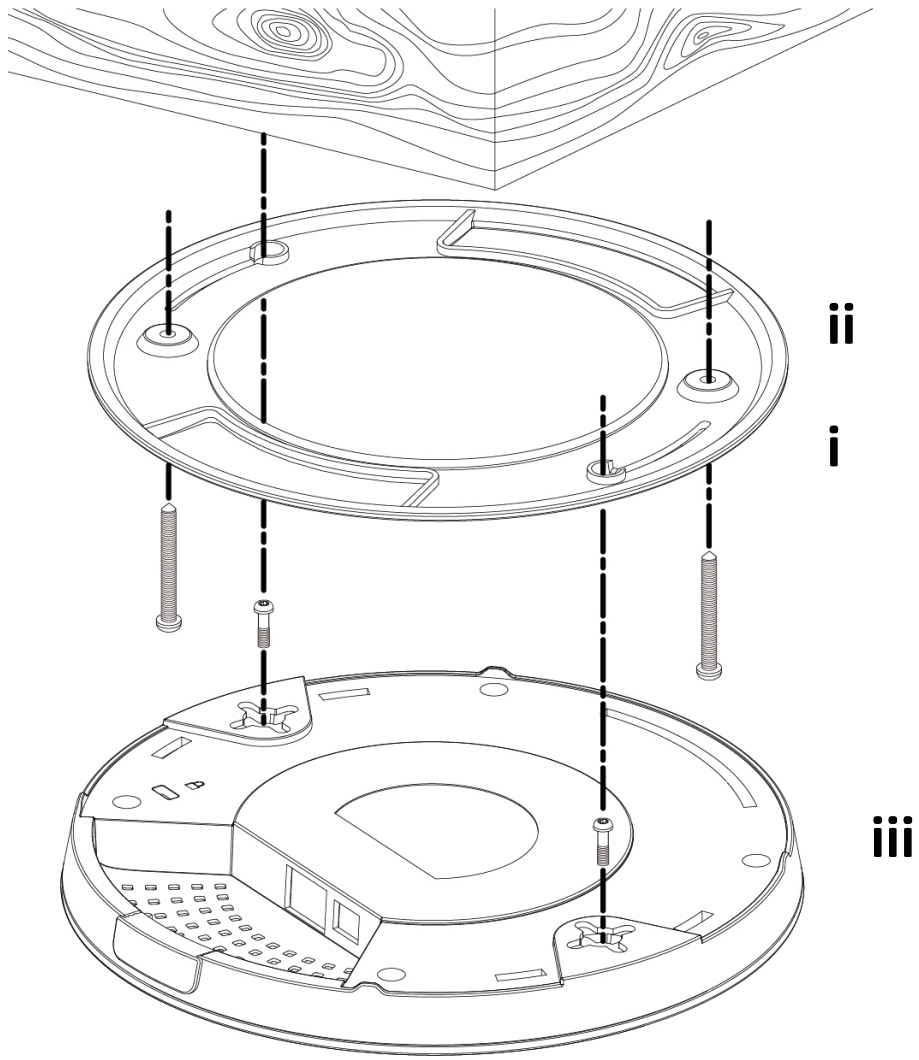

B

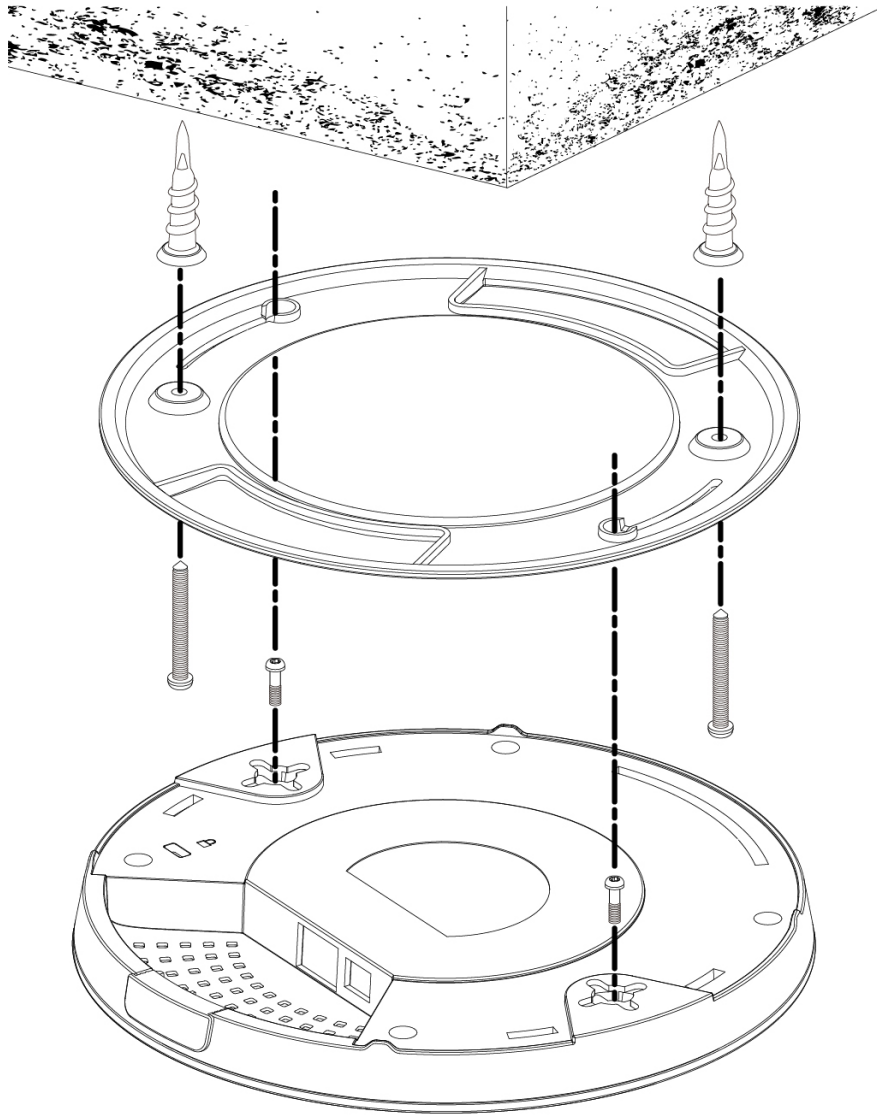

II-3. T-Rail Mount

To mount the access point to a T-Rail, please follow the instructions below and refer to diagram **C**, **D** & **E**.

1. Select the correct size T-Rail bracket from the two sizes which are included in the package contents.
2. Attach the T-Rail bracket **i** to hole **ii** using screw **iii** (x 2) as shown in **C**.

 ***If you need more space between the access point and the T-Rail, then additionally use bracket **iv** between bracket **i** and hole **ii** (x 2), and use the longer screws (x 2) included in the package contents.***

3. Clip the access point onto your T-Rail using the now attached T-Rail bracket.

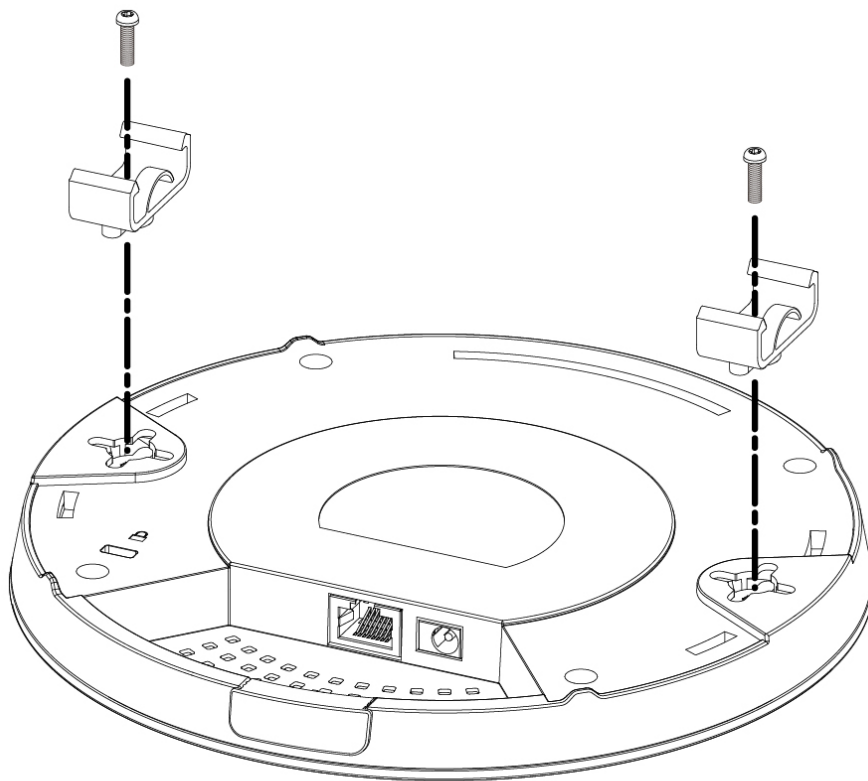

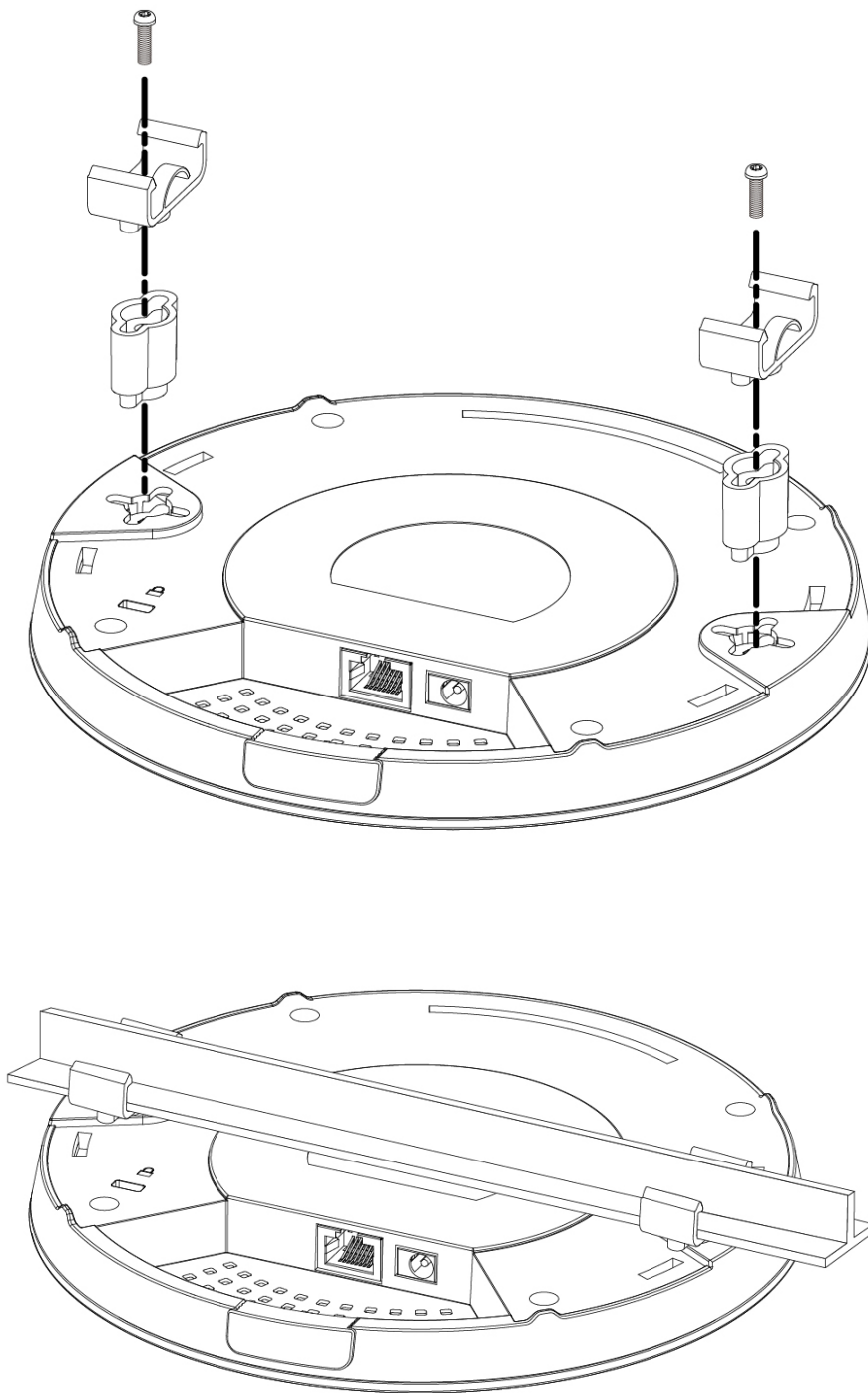

III. Quick Setup

Your access point can be up and running in just a few minutes. This quick installation guide will help to set up your access point in its default AP mode and configure its basic settings. For use a Managed AP within an AP array no settings are necessary. Configurations can be made from your Controller AP (refer to **Edimax Pro NMS**).

III-1. Initial Setup

1. Connect the access point to a computer via Ethernet cable.
2. Connect the power adapter to the access point's 12V DC port and plug the power adapter into a power supply using the included cable.

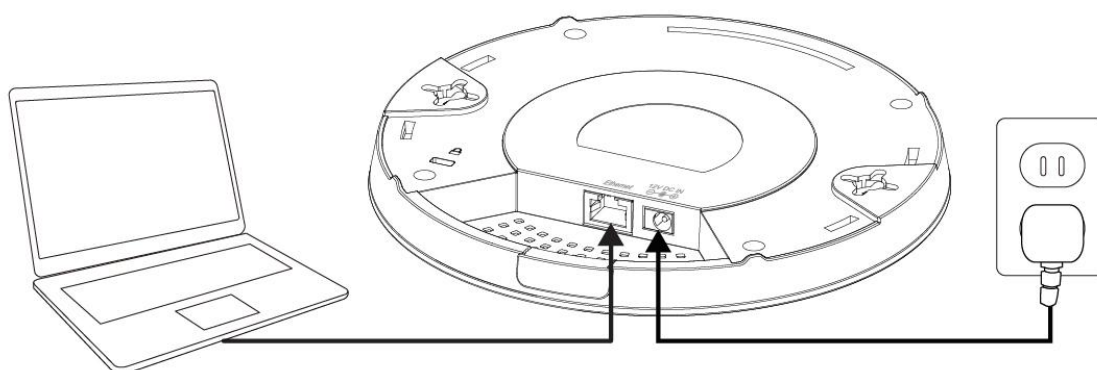

3. Please wait a moment for the access point to start up. The access point is ready when the LED is **blue**.
4. Set your computer's IP address to **192.168.2.x** where **x** is a number in the range **3 – 100**. If you are unsure how to do this, please refer to the user manual for more information.

 **Please ensure there are no other active network connections on your computer (disconnect Wi-Fi connections and Ethernet cables).**

5. Enter the access point's default IP address **192.168.2.2** into the URL bar of a web browser.



6. You will be prompted for a username and password. Enter the default username “admin” and the default password “1234”.

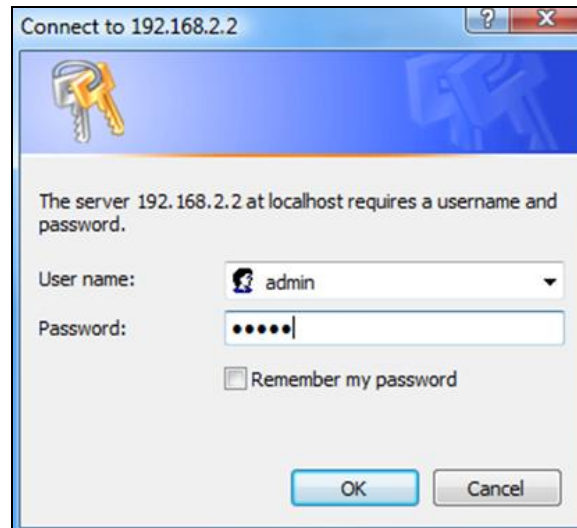

7. You will arrive the “System Information” screen shown below.

EDIMAX Pro Home | Logout | Global (English) ▼

CAP1200 **Information** Network Settings Wireless Settings Management Advanced

Information

- > System Information
- > Wireless Clients
- > Wireless Monitor
- > Log

System Information

System	
Model	CAP1200
Product Name	AP74DA383071F6
Uptime	0 day 00:01:02
Boot from	Internal memory
Version	1.1.0
MAC Address	74:DA:38:30:71:F6
Management VLAN ID	1
IP Address	192.168.0.108 <input type="button" value="Refresh"/>
Default Gateway	192.168.0.1
DNS	192.168.0.1
DHCP Server	192.168.0.1

Wired LAN Port Settings

Wired LAN Port	Status	VLAN Mode/ID
Wired Port (#1)	Connected (100 Mbps Full-Duplex)	Untagged Port / 1

8. Next, please follow the instructions below in **II-2. Basic Settings** to configure the access point’s basic settings.



For more advanced configurations, please refer to IV. Browser Based Configuration Interface.

III-2. Basic Settings

The instructions below will help you to configure the following basic settings of the access point:

- ***LAN IP Address***
- ***2.4GHz & 5GHz SSID & Security***
- ***Administrator Name & Password***
- ***Time & Date***



It is recommended you configure these settings before using the access point.

- 1.** To change the access point's LAN IP address, go to **“Network Settings” > “LAN-side IP Address”** and you will see the screen below.

LAN-side IP Address	
IP Address Assignment	DHCP Client ▼
IP Address	192.168.2.2
Subnet Mask	255.255.255.0
Default Gateway	From DHCP ▼
Primary DNS Address	From DHCP ▼ 0.0.0.0
Secondary DNS Address	From DHCP ▼ 0.0.0.0

- 2.** Enter the IP address settings you wish to use for your access point. You can use a dynamic (DHCP) or static IP address, depending on your network environment. Click **“Apply”** to save the changes and wait a few moments for the access point to reload.



When you change your access point's IP address, you need to use the new IP address to access the browser based configuration interface instead of the default IP 192.168.2.2.

- 3.** To change the SSID of your access point's 2.4GHz wireless network(s), go to **“Wireless Settings” > “2.4GHz 11bgn” > “Basic”**. Enter the new SSID for your 2.4GHz wireless network in the **“SSID1”** field and click **“Apply”**.



To utilize multiple 2.4GHz SSIDs, open the drop down menu labelled “Enable SSID number” and select how many SSIDs you require. Then enter a new SSID in the corresponding numbered fields below, before clicking “Apply”.

2.4GHz Basic Settings	
Wireless	<input type="radio"/> Enable <input checked="" type="radio"/> Disable
Band	11b/g/n ▼
Enable SSID number	1 ▼
SSID1	CAP1200-3071F6_G VLAN ID 1
Auto Channel	<input checked="" type="radio"/> Enable <input type="radio"/> Disable
Auto Channel Range	Ch 1 - 11 ▼
Auto Channel Interval	One day ▼ <input type="checkbox"/> Change channel even if clients are connected
Channel Bandwidth	Auto ▼
BSS BasicRateSet	1,2,5,5,11 Mbps ▼

- 4.** To configure the security of your access point’s 2.4GHz wireless network(s), go to **“Wireless Settings” > “2.4GHz 11bgn” > “Security”**. Select an “Authentication Method” and enter a “Pre-shared Key” or “Encryption Key” depending on your choice, then click “Apply”.



If using multiple SSIDs, specify which SSID to configure using the “SSID” drop down menu.

2.4GHz Wireless Security Settings	
SSID	CAP1200-3071F6_G ▼
Broadcast SSID	Enable ▼
Wireless Client Isolation	Disable ▼
Load Balancing	50 /50
Authentication Method	No Authentication ▼
Additional Authentication	No additional authentication ▼

5. Go to **“Wireless Settings” > “5GHz 11ac 11an”** and repeat steps **3 & 4** for the access point’s 5GHz wireless network.
6. To change the administrator name and password for the browser based configuration interface, go to **“Management” > “Admin”**.

Account to Manage This Device	
Administrator Name	<input type="text" value="admin"/>
Administrator Password	<input type="password" value="•••••"/> (4-32 Characters)
	<input type="password" value="•••••"/> (Confirm)
<input type="button" value="Apply"/>	

7. Complete the **“Administrator Name”** and **“Administrator Password”** fields and click **“Apply”**.
8. To set the correct time for your access point, go to **“Management” > “Date and Time”**.

Date and Time Settings	
Local Time	2012 <input type="button" value="v"/> Year Jan <input type="button" value="v"/> Month 1 <input type="button" value="v"/> Day
	0 <input type="button" value="v"/> Hours 00 <input type="button" value="v"/> Minutes 00 <input type="button" value="v"/> Seconds
<input type="button" value="Acquire Current Time from Your PC"/>	
NTP Time Server	
Use NTP	<input type="checkbox"/> Enable
Server Name	<input type="text"/>
Update Interval	24 <input type="text"/> hours
Time Zone	
Time Zone	(GMT) Greenwich Mean Time: Dublin, Edinburgh, Lisbon, London <input type="button" value="v"/>

9. Set the correct time and time zone for your access point using the drop down menus. The access point also supports NTP (Network Time Protocol)

so alternatively you can enter the host name or IP address of a time server. Click “Apply” when you are finished.



You can use the “Acquire Current Time from your PC” button if you wish to set the access point to the same time as your PC.

- 10.** The basic settings of your access point are now configured. Please refer to **II. Hardware Installation** for guidance on connecting your access point to a router or PoE switch.

IV. Browser Based Configuration Interface



In Managed AP mode some functions of the browser based configuration interface are disabled. Please use Edimax Pro NMS on your Controller AP to configure your Managed AP(s).

The browser-based configuration interface enables you to configure the access point's advanced features. The CAP1200 features a range of advanced functions such as MAC filtering, MAC RADIUS authentication, VLAN configurations, up to 32 SSIDs and many more. To access the browser based configuration interface:

1. Connect a computer to your access point using an Ethernet cable.
2. Enter your access point's IP address in the URL bar of a web browser. The access point's default IP address is **192.168.2.2**.
3. You will be prompted for a username and password. The default username is "admin" and the default password is "1234", though it was recommended that you change the password during setup (see III-2. Basic Settings).



If you cannot remember your password, reset the access point back to its factory default settings. Refer to I-5. Reset

4. You will arrive at the "System Information" screen shown below.

The screenshot shows the Edimax Pro CAP1200 web interface. The top navigation bar includes "Home | Logout | Global (English)". The main menu has tabs for "Information", "Network Settings", "Wireless Settings", "Management", and "Advanced". The "Information" tab is selected, and the "System Information" sub-tab is active. The left sidebar shows a menu with "System Information", "Wireless Clients", "Wireless Monitor", and "Log". The main content area displays the following system information:

System	
Model	CAP1200
Product Name	AP74DA383071F6
Uptime	0 day 00:01:02
Boot from	Internal memory
Version	1.1.0
MAC Address	74:DA:38:30:71:F6
Management VLAN ID	1
IP Address	192.168.0.108 <input type="button" value="Refresh"/>
Default Gateway	192.168.0.1
DNS	192.168.0.1
DHCP Server	192.168.0.1

Below the system information is the "Wired LAN Port Settings" section:

Wired LAN Port	Status	VLAN Mode/ID
Wired Port (#1)	Connected (100 Mbps Full-Duplex)	Untagged Port / 1

5. Use the menu across the top and down the left side to navigate.

The screenshot shows the EDIMAX Pro web interface. The top navigation bar includes 'C A P 1 2 0 0', 'Information', 'Network Settings', 'Wireless Settings' (highlighted), 'Management', and 'Advanced'. The left sidebar shows 'Wireless Settings' expanded with sub-items: '2.4GHz 11bgn' (expanded to 'Basic', 'Advanced', 'Security', 'WDS', 'Schedule'), '5GHz 11ac 11an' (expanded to 'Basic', 'Advanced', 'Security', 'WDS', 'Schedule'), 'WPS', 'RADIUS' (expanded to 'RADIUS Settings', 'Internal Server', 'RADIUS Accounts'), 'MAC Filter', and 'WMM'. Two red arrows point from the 'Wireless Settings' menu item to the 'Basic' sub-item and from the 'Basic' sub-item to the left. Below the screenshot, the 'Apply' button is circled in red, and the 'Cancel' button is visible next to it.

6. Click “Apply” to save changes and reload the access point, or “Cancel” to cancel changes.

 ***Please wait a few seconds for the access point to reload after you “Apply” changes, as shown below.***

Configuration is complete. Reloading now... Please wait for seconds.

7. Please refer to the following chapters for full descriptions of the browser based configuration interface features.

IV-1. Information

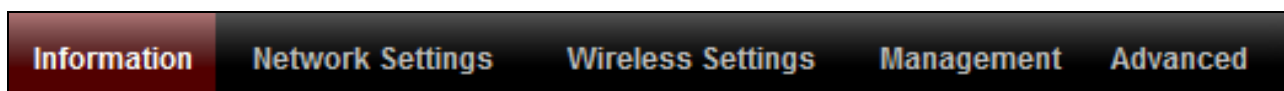

Screenshots displayed are examples. The information shown on your screen will vary depending on your configuration.

IV-1-1. System Information

> System Information

The “System Information” page displays basic system information about the access point.

System	
Model	CAP1200
Product Name	AP74DA383071F6
Uptime	0 day 00:13:03
Boot from	Internal memory
Version	1.1.0
MAC Address	74:DA:38:30:71:F6
Management VLAN ID	1
IP Address	192.168.0.108 <input type="button" value="Refresh"/>
Default Gateway	192.168.0.1
DNS	192.168.0.1
DHCP Server	192.168.0.1

Wired LAN Port Settings

Wired LAN Port	Status	VLAN Mode/ID
Wired Port (#1)	Connected (100 Mbps Full-Duplex)	Untagged Port / 1

Wireless 2.4GHz

Status	Enabled
MAC Address	00:AA:BB:CC:DD:10
Channel	Ch 4 + 8 (Auto)
Transmit Power	100%

Wireless 2.4GHz /SSID

SSID	Authentication Method	Encryption Type	VLAN ID	Additional Authentication	Wireless Client Isolation
CAP1200-CCDD10_G	No Authentication	No Encryption	1	No additional authentication	Disabled

Wireless 2.4GHz /WDS Disabled

MAC Address	Encryption Type	VLAN Mode/ID
No WDS entries.		

Wireless 5GHz

Status	Enabled
MAC Address	00:AA:BB:CC:DD:11
Channel	Ch 36 + 40 + 44 + 48 (Auto)
Transmit Power	100%

Wireless 5GHz /SSID

SSID	Authentication Method	Encryption Type	VLAN ID	Additional Authentication	Wireless Client Isolation
CAP1200-CCDD10_A	No Authentication	No Encryption	1	No additional authentication	Disabled

Wireless 5GHz /WDS Disabled

MAC Address	Encryption Type	VLAN Mode/ID
No WDS entries.		

System	
Model	Displays the model number of the access point.
Product Name	Displays the product name for reference, which consists of “AP” plus the MAC address.
Uptime	Displays the total time since the device was turned on.
Boot From	Displays information for the booted hardware, booted from either USB or internal memory.
Version	Displays the firmware version.
MAC Address	Displays the access point’s MAC address.
Management VLAN ID	Displays the management VLAN ID.
IP Address	Displays the IP address of this device. Click “Refresh” to update this value.
Default Gateway	Displays the IP address of the default gateway.
DNS	IP address of DNS (Domain Name Server)
DHCP Server	IP address of DHCP Server.

Wired LAN Port Settings	
Wired LAN Port	Specifies which LAN port (1 or 2).
Status	Displays the status of the specified LAN port (connected or disconnected).
VLAN Mode/ID	Displays the VLAN mode (tagged or untagged) and VLAN ID for the specified LAN port. See IV-2-3. VLAN

Wireless 2.4GHz (5GHz)	
Status	Displays the status of the 2.4GHz or 5GHz wireless (enabled or disabled).
MAC Address	Displays the access point’s MAC address.
Channel	Displays the channel number the specified wireless frequency is using for broadcast.
Transmit Power	Displays the wireless radio transmit power level as a percentage.

Wireless 2.4GHZ (5GHz) / SSID	
-------------------------------	--

SSID	Displays the SSID name(s) for the specified frequency.
Authentication Method	Displays the authentication method for the specified SSID. See IV-3. Wireless Settings
Encryption Type	Displays the encryption type for the specified SSID. See IV-3. Wireless Settings
VLAN ID	Displays the VLAN ID for the specified SSID. See IV-2-3. VLAN
Additional Authentication	Displays the additional authentication type for the specified SSID. See IV-3. Wireless Settings
Wireless Client Isolation	Displays whether wireless client isolation is in use for the specified SSID. See IV-2-3. VLAN

Wireless 2.4GHZ (5GHz) / WDS Status	
MAC Address	Displays the peer access point's MAC address.
Encryption Type	Displays the encryption type for the specified WDS. See IV-3-1-4. WDS
VLAN Mode/ID	Displays the VLAN ID for the specified WDS. See IV-3-1-4. WDS

Refresh	Click to refresh all information.
----------------	-----------------------------------

IV-1-2. Wireless Clients

> Wireless Clients

The “Wireless Clients” page displays information about all wireless clients connected to the access point on the 2.4GHz or 5GHz frequency.

Refresh time							
Auto Refresh time	<input checked="" type="radio"/> 5 seconds <input type="radio"/> 1 second <input type="radio"/> Disable						
Manual Refresh	Refresh						

2.4GHz WLAN Client Table							
#	SSID	MAC Address	Tx	Rx	Signal (%)	Connected Time	Idle Time
1	CAP1200-CCDD10_G	F8:A9:D0:0B:7D:A8	0 Bytes	1.8 KBytes	100	25 secs	3

5GHz WLAN Client Table							
#	SSID	MAC Address	Tx	Rx	Signal (%)	Connected Time	Idle Time
No wireless client							

Refresh time	
Auto Refresh Time	Select a time interval for the client table list to automatically refresh.
Manual Refresh	Click refresh to manually refresh the client table.

2.4GHz (5GHz) WLAN Client Table	
SSID	Displays the SSID which the client is connected to.
MAC Address	Displays the MAC address of the client.
Tx	Displays the total data packets transmitted by the specified client.
Rx	Displays the total data packets received by the specified client.
Signal (%)	Displays the wireless signal strength for the specified client.
Connected Time	Displays the total time the wireless client has

	been connected to the access point.
Idle Time	Client idle time is the time for which the client has not transmitted any data packets i.e. is idle.
Vendor	The vendor of the client's wireless adapter is displayed here.

IV-1-3. Wireless Monitor

> Wireless Monitor

Wireless Monitor is a tool built into the access point to scan and monitor the surrounding wireless environment. Select a frequency and click “Scan” to display a list of all SSIDs within range along with relevant details for each SSID.

Wireless Monitor	
Site Survey	<input checked="" type="radio"/> Wireless 2.4G/ 5G <input type="radio"/> 2.4G <input type="radio"/> 5G <input type="button" value="Scan"/>
Channel Survey result	<input type="button" value="Export"/>

Wireless 2.4GHz						
Ch	SSID	MAC Address	Security	Signal (%)	Type	Vendor
1	Matt	00:E0:4C:81:96:C1	WPA2PSK/AES	100	11b/g/n	REALTEK SEMICONDUCTOR CORP.

Wireless 5GHz						
Ch	SSID	MAC Address	Security	Signal (%)	Type	Vendor
You can click Scan button to start.						

Wireless Monitor	
Site Survey	Select which frequency (or both) to scan, and click “Scan” to begin.
Channel Survey Result	After a scan is complete, click “Export” to save the results to local storage.

Site Survey Results	
Ch	Displays the channel number used by the specified SSID.
SSID	Displays the SSID identified by the scan.
MAC Address	Displays the MAC address of the wireless router/access point for the specified SSID.
Security	Displays the authentication/encryption type of the specified SSID.

Signal (%)	Displays the current signal strength of the SSID.
Type	Displays the 802.11 wireless networking standard(s) of the specified SSID.
Vendor	Displays the vendor of the wireless router/access point for the specified SSID.

IV-1-4. Log

> System Log

The system log displays system operation information such as up time and connection processes. This information is useful for network administrators.



When the log is full, old entries are overwritten.

```

Jan 1 00:02:49 [SYSTEM]: LAN, Port[1] link status is changed to down
Jan 1 00:02:25 [SYSTEM]: LAN, Port[1] link is changed to 100Mbps-Full-Duplex
Jan 1 00:00:58 [SYSTEM]: WLAN[2.4G], Best channel selection start, switch to channel 1 + 5
Jan 1 00:00:38 [SYSTEM]: WLAN[5G], Skip Best channel selection and wait for next time
Jan 1 00:00:12 [SYSTEM]: LAN, Port[1] link status is changed to down
Jan 1 00:00:12 [SYSTEM]: LAN, Port[0] link status is changed to down
Jan 1 00:00:11 [SYSTEM]: TFTP server, Stopping
Jan 1 00:00:11 [SYSTEM]: FTP server, Stopping
Jan 1 00:00:11 [SYSTEM]: HTTPS, start
Jan 1 00:00:11 [SYSTEM]: HTTP, start
Jan 1 00:00:11 [SYSTEM]: LAN, Firewall Disabled
Jan 1 00:00:11 [SYSTEM]: LAN, NAT Disabled
Jan 1 00:00:11 [SYSTEM]: NET, Firewall Disabled
Jan 1 00:00:11 [SYSTEM]: NET, NAT Disabled
Jan 1 00:00:10 [SYSTEM]: LEDs, light on specific LEDs
Jan 1 00:00:07 [SYSTEM]: WLAN[5G], Channel = AutoSelect
Jan 1 00:00:07 [SYSTEM]: WLAN[5G], Wireless Mode = 11ACVHT80
Jan 1 00:00:02 [SYSTEM]: WLAN[2.4G], Channel = AutoSelect
Jan 1 00:00:02 [SYSTEM]: WLAN[2.4G], Wireless Mode = 11NGHT40MINUS
Jan 1 00:00:02 [SYSTEM]: DHCP, start
Jan 1 00:00:02 [SYSTEM]: LAN, start
Jan 1 00:00:02 [SYSTEM]: Bridge, start

```



Save	Click to save the log as a file on your local computer.
Clear	Clear all log entries.
Refresh	Refresh the current log.

The following information/events are recorded by the log:

- ◆ **USB**
Mount & unmount
- ◆ **Wireless Client**
Connected & disconnected
Key exchange success & fail
- ◆ **Authentication**
Authentication fail or successful.
- ◆ **Association**
Success or fail
- ◆ **WPS**
M1 - M8 messages
WPS success
- ◆ **Change Settings**
- ◆ **System Boot**
Displays current model name
- ◆ **NTP Client**
- ◆ **Wired Link**
LAN Port link status and speed status
- ◆ **Proxy ARP**
Proxy ARP module start & stop
- ◆ **Bridge**
Bridge start & stop.
- ◆ **SNMP**
SNMP server start & stop.
- ◆ **HTTP**
HTTP start & stop.
- ◆ **HTTPS**
HTTPS start & stop.
- ◆ **SSH**
SSH-client server start & stop.
- ◆ **Telnet**
Telnet-client server start or stop.
- ◆ **WLAN (2.4G)**
WLAN (2.4G) channel status and country/region status
- ◆ **WLAN (5G)**
WLAN (5G) channel status and country/region status

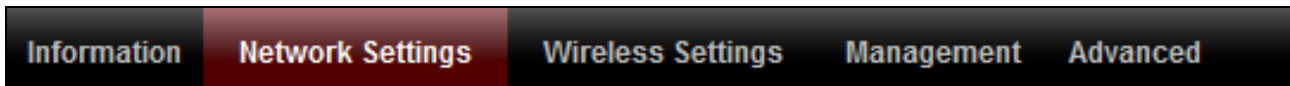
IV-2. Network Settings



 *Screenshots displayed are examples. The information shown on your screen will vary depending on your configuration.*

IV-2-1. LAN-Side IP Address

> LAN-side IP Address The “LAN-side IP address” page allows you to configure your access point on your Local Area Network (LAN). You can enable the access point to dynamically receive an IP address from your router’s DHCP server or you can specify a static IP address for your access point, as well as configure DNS servers.

 *The access point’s default IP address is 192.168.2.2.*

LAN-side IP Address	
IP Address Assignment	DHCP Client ▼
IP Address	192.168.2.2
Subnet Mask	255.255.255.0
Default Gateway	From DHCP ▼
Primary DNS Address	From DHCP ▼ 0.0.0.0
Secondary DNS Address	From DHCP ▼ 0.0.0.0

LAN-side IP Address	
IP Address Assignment	Select “DHCP Client” for your access point to be assigned a dynamic IP address from your router’s DHCP server, or select “Static IP” to manually specify a static/fixed IP address for your access point (below).
IP Address	Specify the IP address here. This IP address will be assigned to your access point and will replace the default IP address.
Subnet Mask	Specify a subnet mask. The default value is 255.255.255.0

Default Gateway	For DHCP users, select “From DHCP” to get default gateway from your DHCP server or “User-Defined” to enter a gateway manually. For static IP users, the default value is blank.
------------------------	---

DHCP users can select to get DNS servers’ IP address from DHCP or manually enter a value. For static IP users, the default value is blank.

Primary Address	DHCP users can select “From DHCP” to get primary DNS server’s IP address from DHCP or “User-Defined” to manually enter a value. For static IP users, the default value is blank.
Secondary Address	Users can manually enter a value when DNS server’s primary address is set to “User-Defined”.

IV-2-2. LAN Port

> LAN Port

The “LAN Port” page allows you to configure the settings for your access point’s two wired LAN (Ethernet) ports.

Wired LAN Port Settings				
Wired LAN Port	Enable	Speed & Duplex	Flow Control	802.3az
Wired Port (#1)	Enabled ▾	Auto ▾	Enabled ▾	Enabled ▾

Wired LAN Port	Identifies LAN port 1 or 2.
Enable	Enable/disable specified LAN port.
Speed & Duplex	Select a speed & duplex type for specified LAN port, or use the “Auto” value. LAN ports can operate up to 1000Mbps and full-duplex enables simultaneous data packets transfer/receive.
Flow Control	Enable/disable flow control. Flow control can pause new session request until current data processing is complete, in order to avoid device overloads under heavy traffic.
802.3az	Enable/disable 802.3az. 802.3az is an Energy Efficient Ethernet feature which disables unused interfaces to reduce power usage.

IV-2-3. VLAN

> VLAN

The “VLAN” (Virtual Local Area Network) enables you to configure VLAN settings. A VLAN is a local area network which maps workstations virtually instead of physically and allows you to group together or isolate users from each other. VLAN IDs 1 – 4095 are supported.



VLAN IDs in the range 1 – 4095 are supported.

VLAN Interface		
Wired LAN Port	VLAN Mode	VLAN ID
Wired Port (#1)	Untagged Port ▾	1
Wireless 2.4GHz	VLAN Mode	VLAN ID
SSID [CAP1200-CCDD10_G]	Untagged Port	1
Wireless 5GHz	VLAN Mode	VLAN ID
SSID [CAP1200-CCDD10_A]	Untagged Port	1

Management VLAN	
VLAN ID	1

VLAN Interface	
Wired LAN Port/Wireless	Identifies LAN port 1 or 2 and wireless SSIDs.
VLAN Mode	Select “Tagged Port” or “Untagged Port” for specified LAN interface.
VLAN ID	Set a VLAN ID for specified interface, if “Untagged Port” is selected.

Management VLAN	
VLAN ID	Specify the VLAN ID of the management VLAN. Only the hosts belonging to the same VLAN can manage the device.

IV-3. Wireless Settings



Screenshots displayed are examples. The information shown on your screen will vary depending on your configuration.

IV-3-1. 2.4GHz 11bgn

➤ 2.4GHz 11bgn

The “2.4GHz 11bgn” menu allows you to view and configure information for your access point’s 2.4GHz wireless network across five categories: Basic, Advanced, Security, WDS & Schedule.

IV-3-1-1. Basic

> Basic

The “Basic” screen displays basic settings for your access point’s 2.4GHz Wi-Fi network (s).

2.4GHz Basic Settings	
Wireless	<input type="radio"/> Enable <input checked="" type="radio"/> Disable
Band	11b/g/n ▼
Enable SSID number	1 ▼
SSID1	CAP1200-3071F6_G VLAN ID 1
Auto Channel	<input checked="" type="radio"/> Enable <input type="radio"/> Disable
Auto Channel Range	Ch 1 - 11 ▼
Auto Channel Interval	One day ▼ <input type="checkbox"/> Change channel even if clients are connected
Channel Bandwidth	Auto ▼
BSS BasicRateSet	1,2,5,5,11 Mbps ▼



Auto Channel	<input type="radio"/> Enable <input checked="" type="radio"/> Disable
Channel	Ch 11, 2462MHz ▼
Channel Bandwidth	Auto, +Ch 7 ▼
BSS BasicRateSet	1,2,5,5,11 Mbps ▼

Wireless	Enable or disable the access point's 2.4GHz wireless radio. When disabled, no 2.4GHz SSIDs will be active.
Band	Select the wireless standard used for the access point. Combinations of 802.11b, 802.11g & 802.11n can be selected.
Enable SSID Number	Select how many SSIDs to enable for the 2.4GHz frequency from the drop down menu. A maximum of 16 can be enabled.
SSID#	Enter the SSID name for the specified SSID (up to 16). The SSID can consist of any combination of up to 32 alphanumeric characters.
VLAN ID	Specify a VLAN ID for each SSID.
Auto Channel	Enable/disable auto channel selection. Auto channel selection will automatically set the wireless channel for the access point's 2.4GHz frequency based on availability and potential interference. When disabled, select a channel manually as shown in the next table.
Auto Channel Range	Select a range from which the auto channel setting (above) will choose a channel.
Auto Channel Interval	Specify a frequency for how often the auto channel setting will check/reassign the wireless channel. Check/uncheck the "Change channel even if clients are connected" box according to your preference.
Channel Bandwidth	Set the channel bandwidth: 20MHz (lower performance but less interference), 40MHz (higher performance but potentially higher interference) or Auto (automatically select based on interference level).
BSS BasicRateSet	Set a Basic Service Set (BSS) rate: this is a series of rates to control communication frames for wireless clients.

When auto channel is disabled, select a wireless channel manually:

Channel	Select a wireless channel from 1 – 11.
Channel Bandwidth	Set the channel bandwidth: 20MHz (lower performance but less interference), 40MHz (higher performance but potentially higher interference) or Auto (automatically select based on interference level).
BSS BasicRate Set	Set a Basic Service Set (BSS) rate: this is a series of rates to control communication frames for wireless clients.

IV-3-1-2. Advanced

> Advanced

These settings are for experienced users only. Please do not change any of the values on this page unless you are already familiar with these functions.



Changing these settings can adversely affect the performance of your access point.

2.4GHz Advanced Settings	
Contention Slot	Short ▾
Preamble Type	Short ▾
Guard Interval	Short GI ▾
802.11g Protection	<input checked="" type="radio"/> Enable <input type="radio"/> Disable
802.11n Protection	<input checked="" type="radio"/> Enable <input type="radio"/> Disable
DTIM Period	1 (1-255)
RTS Threshold	2347 (1-2347)
Fragment Threshold	2346 (256-2346)
Multicast Rate	Auto ▾
Tx Power	100% ▾
Beacon Interval	100 (40-1000 ms)
Station idle timeout	60 (30-65535 seconds)

Contention Slot	Select “Short” or “Long” – this value is used for contention windows in WMM (see IV-3-6. WMM).
Preamble Type	Set the wireless radio preamble type. The preamble type in 802.11 based wireless communication defines the length of the CRC (Cyclic Redundancy Check) block for communication between the access point and roaming wireless adapters. The default value is “Short Preamble”.
Guard Interval	Set the guard interval. A shorter interval can improve performance.

802.11g Protection	Enable/disable 802.11g protection, which increases reliability but reduces bandwidth (clients will send Request to Send (RTS) to access point, and access point will broadcast Clear to Send (CTS), before a packet is sent from client.)
802.11n Protection	Enable/disable 802.11n protection, which increases reliability but reduces bandwidth (clients will send Request to Send (RTS) to access point, and access point will broadcast Clear to Send (CTS), before a packet is sent from client.)
DTIM Period	Set the DTIM (delivery traffic indication message) period value of the wireless radio. The default value is 1.
RTS Threshold	Set the RTS threshold of the wireless radio. The default value is 2347.
Fragment Threshold	Set the fragment threshold of the wireless radio. The default value is 2346.
Multicast Rate	Set the transfer rate for multicast packets or use the "Auto" setting.
Tx Power	Set the power output of the wireless radio. You may not require 100% output power. Setting a lower power output can enhance security since potentially malicious/unknown users in distant areas will not be able to access your signal.
Beacon Interval	Set the beacon interval of the wireless radio. The default value is 100.
Station idle timeout	Set the interval for keepalive messages from the access point to a wireless client to verify if the station is still alive/active.

IV-3-1-3. Security

➤ Security

The access point provides various security options (wireless data encryption). When data is encrypted, information transmitted wirelessly cannot be read by anyone who does not know the correct encryption key.



It's essential to configure wireless security in order to prevent unauthorised access to your network.



Select hard-to-guess passwords which include combinations of numbers, letters and symbols, and change your password regularly.

2.4GHz Wireless Security Settings	
SSID	CAP1200-3071F6_G ▼
Broadcast SSID	Enable ▼
Wireless Client Isolation	Disable ▼
Load Balancing	50 /50
Authentication Method	No Authentication ▼
Additional Authentication	No additional authentication ▼

SSID Selection	Select which SSID to configure security settings for.
Broadcast SSID	Enable or disable SSID broadcast. When enabled, the SSID will be visible to clients as an available Wi-Fi network. When disabled, the SSID will not be visible as an available Wi-Fi network to clients – clients must manually enter the SSID in order to connect. A hidden (disabled) SSID is typically more secure than a visible (enabled) SSID.
Wireless Client Isolation	Enable or disable wireless client isolation. Wireless client isolation prevents clients connected to the access point from communicating with each other and improves security. Typically, this function is useful for corporate environments or public hot spots and can prevent brute force attacks on clients' usernames and passwords.
Load Balancing	Load balancing limits the number of wireless clients connected to an SSID. Set a load balancing value (maximum 50).
Authentication Method	Select an authentication method from the drop down menu and refer to the information below appropriate for your method.
Additional Authentication	Select an additional authentication method from the drop down menu and refer to the information below (IV-3-1-3-6.) appropriate for your method.

IV-3-1-3-1. No Authentication

Authentication is disabled and no password/key is required to connect to the access point.



Disabling wireless authentication is not recommended. When disabled, anybody within range can connect to your device's SSID.

IV-3-1-3-2. WEP

WEP (Wired Equivalent Privacy) is a basic encryption type. For a higher level of security consider using WPA encryption.

Key Length	Select 64-bit or 128-bit. 128-bit is more secure than 64-bit and is recommended.
Key Type	Choose from “ASCII” (any alphanumerical character 0-9, a-z and A-Z) or “Hex” (any characters from 0-9, a-f and A-F).
Default Key	Select which encryption key (1 – 4 below) is the default key. For security purposes, you can set up to four keys (below) and change which is the default key.
Encryption Key 1 – 4	Enter your encryption key/password according to the format you selected above.

IV-3-1-3-3. IEEE802.1x/EAP

Key Length	Select 64-bit or 128-bit. 128-bit is more secure than 64-bit and is recommended.
-------------------	--

IV-3-1-3-4. WPA-PSK

WPA-PSK is a secure wireless encryption type with strong data protection and user authentication, utilizing 128-bit encryption keys.

WPA Type	Select from WPA/WPA2 Mixed Mode-PSK, WPA2 or WPA only. WPA2 is safer than WPA only, but not supported by all wireless clients. Please make sure your wireless client supports your selection.
Encryption	Select “TKIP/AES Mixed Mode” or “AES” encryption type.
Key Renewal Interval	Specify a frequency for key renewal in minutes.
Pre-Shared Key Type	Choose from “Passphrase” (8 – 63 alphanumeric characters) or “Hex” (up to 64

	characters from 0-9, a-f and A-F).
Pre-Shared Key	Please enter a security key/password according to the format you selected above.

IV-3-1-3-5. WPA-EAP

WPA Type	Select from WPA/WPA2 Mixed Mode-EAP, WPA2-EAP or WPA-EAP.
Encryption Type	Select “TKIP/AES Mixed Mode” or “AES” encryption type.
Key Renewal Interval	Specify a frequency for key renewal in minutes.



WPA-EAP must be disabled to use MAC-RADIUS authentication.

IV-3-1-3-6. Additional Authentication

Additional wireless authentication methods can also be used:



WPS must be disabled to use additional authentication. See IV-3-3. for WPS settings.

MAC Address Filter

Restrict wireless clients access based on MAC address specified in the MAC filter table.



See IV-3-5.MAC Filter to configure MAC filtering.

MAC Filter & MAC-RADIUS Authentication

Restrict wireless clients access using both of the above MAC filtering & RADIUS authentication methods.

MAC-RADIUS Authentication

Restrict wireless clients access based on MAC address via a RADIUS server, or password authentication via a RADIUS server.



See IV-3-4.RADIUS to configure RADIUS servers.



WPS must be disabled to use MAC-RADIUS authentication. See IV-3-3. for WPS settings.

MAC RADIUS Password

Use MAC address
 Use the following password

MAC RADIUS Password	<p>Select whether to use MAC address or password authentication via RADIUS server. If you select “Use the following password”, enter the password in the field below. The password should match the “Shared Secret” used in IV-3-4. RADIUS.</p>
----------------------------	--

IV-3-1-4. WDS

> WDS Wireless Distribution System (WDS) can bridge/repeat access points together in an extended network. WDS settings can be configured as shown below.



When using WDS, configure the IP address of each access point to be in the same subnet and ensure there is only one active DHCP server among connected access points, preferably on the WAN side.

WDS must be configured on each access point, using correct MAC addresses. All access points should use the same wireless channel and encryption method.

2.4GHz	
WDS Functionality	Disabled
Local MAC Address	Disabled
	WDS with AP
	Dedicated WDS

WDS Peer Settings	
WDS #1	MAC Address <input type="text"/>
WDS #2	MAC Address <input type="text"/>
WDS #3	MAC Address <input type="text"/>
WDS #4	MAC Address <input type="text"/>

WDS VLAN	
VLAN Mode	Untagged Port <input type="text"/> (Enter at least one MAC address.)
VLAN ID	1 <input type="text"/>

WDS Encryption method	
Encryption	None <input type="text"/> (Enter at least one MAC address.)

2.4GHz	
WDS Functionality	Select “WDS with AP” to use WDS with access point or “WDS Dedicated Mode” to use WDS and also block communication with regular wireless clients. When WDS is used, each access point should be configured with corresponding MAC addresses, wireless channel and wireless encryption method.
Local MAC Address	Displays the MAC address of your access point.

WDS Peer Settings	
WDS #	Enter the MAC address for up to four other WDS devices you wish to connect.

WDS VLAN	
VLAN Mode	Specify the WDS VLAN mode to “Untagged Port” or “Tagged Port”.
VLAN ID	Specify the WDS VLAN ID when “Untagged Port” is selected above.

WDS Encryption method	
Encryption	Select whether to use “None” or “AES” encryption and enter a pre-shared key for AES consisting of 8-63 alphanumeric characters.

IV-3-1-5. Schedule

> Schedule

The schedule feature allows you to automate the wireless network for specified times.

Check/uncheck the box “Enable Wireless Schedule” to enable/disable the wireless scheduling function.



The access point’s time and date settings must be set in order to use this function.

2.4GHz Wireless Schedule

Enable the wireless network during the following schedules.

This function will not work until date and time are set. [Date and Time Settings](#)

Enable Wireless Schedule

Enable	Day	Start Time	End Time
<input type="checkbox"/>	Sunday ▼	00 ▼ : 00 ▼	00 ▼ : 00 ▼
<input type="checkbox"/>	Sunday ▼	00 ▼ : 00 ▼	00 ▼ : 00 ▼
<input checked="" type="checkbox"/>	Monday ▼	07 ▼ : 00 ▼	23 ▼ : 00 ▼
<input checked="" type="checkbox"/>	Tuesday ▼	07 ▼ : 00 ▼	23 ▼ : 00 ▼
<input checked="" type="checkbox"/>	Wednesday ▼	07 ▼ : 00 ▼	23 ▼ : 00 ▼
<input checked="" type="checkbox"/>	Thursday ▼	07 ▼ : 00 ▼	23 ▼ : 00 ▼
<input checked="" type="checkbox"/>	Friday ▼	07 ▼ : 00 ▼	23 ▼ : 00 ▼
<input type="checkbox"/>	Sunday ▼	00 ▼ : 00 ▼	00 ▼ : 00 ▼
<input type="checkbox"/>	Sunday ▼	00 ▼ : 00 ▼	00 ▼ : 00 ▼
<input type="checkbox"/>	Sunday ▼	00 ▼ : 00 ▼	00 ▼ : 00 ▼



Wireless scheduling can save energy and increase the security of your network.

- 1.** Use the “Enable” checkboxes to select schedule(s).
- 2.** Specify a day, start time and end time for the schedule using the drop-down menus.
- 3.** Click “Apply” to save the schedules or “Reset” to reset all values back to default.

IV-3-2. 5GHz 11ac 11an

> 5GHz 11ac 11an

The “5GHz 11ac 11an” menu allows you to view and configure information for your access point’s 5GHz wireless network across five categories: Basic, Advanced, Security, WDS & Schedule.

IV-3-2-1. Basic

> Basic

The “Basic” screen displays basic settings for your access point’s 5GHz Wi-Fi network (s).

5GHz Basic Settings	
Wireless	<input checked="" type="radio"/> Enable <input type="radio"/> Disable
Band	11a/n/ac ▼
Enable SSID number	1 ▼
SSID1	CAP1200-CCDD10_A VLAN ID 1
Auto Channel	<input checked="" type="radio"/> Enable <input type="radio"/> Disable
Auto Channel Range	Band 1 ▼
Auto Channel Interval	One day ▼ <input type="checkbox"/> Change channel even if clients are connected
Channel Bandwidth	Auto 80/40/20 MHz ▼
BSS BasicRateSet	6,12,24 Mbps ▼



Auto Channel	<input type="radio"/> Enable <input checked="" type="radio"/> Disable
Channel	Ch 36, 5.18GHz ▼
Channel Bandwidth	Auto 80/40/20 MHz ▼
BSS BasicRateSet	6,12,24 Mbps ▼

Wireless

Enable or disable the access point’s 5GHz wireless radio. When disabled, no 5GHz SSIDs will be active.

Band	Select the wireless standard used for the access point. Combinations of 802.11a, 802.11n & 802.11ac can be selected.
Enable SSID Number	Select how many SSIDs to enable for the 5GHz frequency from the drop down menu. A maximum of 16 can be enabled.
SSID#	Enter the SSID name for the specified SSID (up to 16). The SSID can consist of any combination of up to 32 alphanumeric characters.
VLAN ID	Specify a VLAN ID for each SSID.
Auto Channel	Enable/disable auto channel selection. Auto channel selection will automatically set the wireless channel for the access point's 5GHz frequency based on availability and potential interference. When disabled, select a channel manually as shown in the next table.
Auto Channel Range	Select a range from which the auto channel setting (above) will choose a channel.
Auto Channel Interval	Specify a frequency for how often the auto channel setting will check/reassign the wireless channel. Check/uncheck the "Change channel even if clients are connected" box according to your preference.
Channel Bandwidth	Set the channel bandwidth: 20MHz (lower performance but less interference), Auto 40/20MHz or Auto 80/40/20MHz (automatically select based on interference level).
BSS BasicRate Set	Set a Basic Service Set (BSS) rate: this is a series of rates to control communication frames for wireless clients.

When auto channel is disabled, select a wireless channel manually:

Channel	Select a wireless channel.
Channel Bandwidth	Set the channel bandwidth: 20MHz (lower performance but less interference), Auto 40/20MHz or Auto 80/40/20MHz (automatically select based on interference level).

BSS BasicRate Set	Set a Basic Service Set (BSS) rate: this is a series of rates to control communication frames for wireless clients.
--------------------------	---

IV-3-2-2. Advanced

> Advanced These settings are for experienced users only. Please do not change any of the values on this page unless you are already familiar with these functions.

 **Changing these settings can adversely affect the performance of your access point.**

5GHz Advanced Settings	
Guard Interval	Short GI ▾
802.11n Protection	<input checked="" type="radio"/> Enable <input type="radio"/> Disable
DTIM Period	1 (1-255)
RTS Threshold	2347 (1-2347)
Fragment Threshold	2346 (256-2346)
Multicast Rate	Auto ▾
Tx Power	100% ▾
Beacon Interval	100 (40-1000 ms)
Station idle timeout	60 (30-65535 seconds)

Guard Interval	Set the guard interval. A shorter interval can improve performance.
802.11n Protection	Enable/disable 802.11n protection, which increases reliability but reduces bandwidth (clients will send Request to Send (RTS) to access point, and access point will broadcast Clear to Send (CTS), before a packet is sent from client.)
DTIM Period	Set the DTIM (delivery traffic indication message) period value of the wireless radio. The default value is 1.
RTS Threshold	Set the RTS threshold of the wireless radio. The default value is 2347.

Fragment Threshold	Set the fragment threshold of the wireless radio. The default value is 2346.
Multicast Rate	Set the transfer rate for multicast packets or use the "Auto" setting.
Tx Power	Set the power output of the wireless radio. You may not require 100% output power. Setting a lower power output can enhance security since potentially malicious/unknown users in distant areas will not be able to access your signal.
Beacon Interval	Set the beacon interval of the wireless radio. The default value is 100.
Station idle timeout	Set the interval for keepalive messages from the access point to a wireless client to verify if the station is still alive/active.

IV-3-2-3. Security

Security

The access point provides various security options (wireless data encryption). When data is encrypted, information transmitted wirelessly cannot be read by anyone who does not know the correct encryption key.



It's essential to configure wireless security in order to prevent unauthorised access to your network.



Select hard-to-guess passwords which include combinations of numbers, letters and symbols, and change your password regularly.

5GHz Wireless Security Settings	
SSID	CAP1200-CCDD10_A ▾
Broadcast SSID	Enable ▾
Wireless Client Isolation	Disable ▾
Load Balancing	50 /50
Authentication Method	No Authentication ▾
Additional Authentication	No additional authentication ▾

SSID Selection	Select which SSID to configure security settings for.
Broadcast SSID	Enable or disable SSID broadcast. When enabled, the SSID will be visible to clients as an available Wi-Fi network. When disabled, the SSID will not be visible as an available Wi-Fi network to clients – clients must manually enter the SSID in order to connect. A hidden (disabled) SSID is typically more secure than a visible (enabled) SSID.

Wireless Client Isolation	Enable or disable wireless client isolation. Wireless client isolation prevents clients connected to the access point from communicating with each other and improves security. Typically, this function is useful for corporate environments or public hot spots and can prevent brute force attacks on clients' usernames and passwords.
Load Balancing	Load balancing limits the number of wireless clients connected to an SSID. Set a load balancing value (maximum 50).
Authentication Method	Select an authentication method from the drop down menu and refer to the information below appropriate for your method.
Additional Authentication	Select an additional authentication method from the drop down menu and refer to the information below appropriate for your method.

Please refer back to **IV-3-1-3. Security** for more information on authentication and additional authentication types.

IV-3-2-4. WDS

➤ WDS

Wireless Distribution System (WDS) can bridge/repeat access points together in an extended network. WDS settings can be configured as shown below.



When using WDS, configure the IP address of each access point to be in the same subnet and ensure there is only one active DHCP server among connected access points, preferably on the WAN side.

WDS must be configured on each access point, using correct MAC addresses. All access points should use the same wireless channel and encryption method.

5GHz WDS Mode	
WDS Functionality	Disabled
Local MAC Address	Disabled WDS with AP Dedicated WDS

WDS Peer Settings	
WDS #1	MAC Address <input type="text"/>
WDS #2	MAC Address <input type="text"/>
WDS #3	MAC Address <input type="text"/>
WDS #4	MAC Address <input type="text"/>

WDS VLAN	
VLAN Mode	Untagged Port <input type="text"/> (Enter at least one MAC address.)
VLAN ID	1

Encryption method	
Encryption	None <input type="text"/> (Enter at least one MAC address.)

5GHz WDS Mode	
WDS Functionality	Select “WDS with AP” to use WDS with access point or “WDS Dedicated Mode” to use WDS and also block communication with regular wireless clients. When WDS is used, each access point should be configured with corresponding MAC addresses, wireless channel and wireless encryption method.
Local MAC Address	Displays the MAC address of your access point.

WDS Peer Settings	
WDS #	Enter the MAC address for up to four other WDA devices you wish to connect.

WDS VLAN	
VLAN Mode	Specify the WDS VLAN mode to “Untagged Port” or “Tagged Port”.
VLAN ID	Specify the WDS VLAN ID when “Untagged Port” is selected above.

WDS Encryption	
Encryption	Select whether to use “None” or “AES” encryption and enter a pre-shared key for AES with 8-63 alphanumeric characters.

IV-3-2-5. Schedule

> Schedule

The schedule feature allows you to automate the wireless network for specified times.

Check/uncheck the box “Enable Wireless Schedule” to enable/disable the wireless scheduling function.



The access point’s time and date settings must be set in order to use this function.

5GHz Wireless Schedule

Enable the wireless network during the following schedules.

This function will not work until date and time are set. [Date and Time Settings](#)

Enable Wireless Schedule

Enable	Day	Start Time	End Time
<input type="checkbox"/>	Sunday ▼	00 ▼ : 00 ▼	00 ▼ : 00 ▼
<input type="checkbox"/>	Sunday ▼	00 ▼ : 00 ▼	00 ▼ : 00 ▼
<input checked="" type="checkbox"/>	Monday ▼	07 ▼ : 00 ▼	23 ▼ : 00 ▼
<input checked="" type="checkbox"/>	Tuesday ▼	07 ▼ : 00 ▼	23 ▼ : 00 ▼
<input checked="" type="checkbox"/>	Wednesday ▼	07 ▼ : 00 ▼	23 ▼ : 00 ▼
<input checked="" type="checkbox"/>	Thursday ▼	07 ▼ : 00 ▼	23 ▼ : 00 ▼
<input checked="" type="checkbox"/>	Friday ▼	07 ▼ : 00 ▼	23 ▼ : 00 ▼
<input type="checkbox"/>	Sunday ▼	00 ▼ : 00 ▼	00 ▼ : 00 ▼
<input type="checkbox"/>	Sunday ▼	00 ▼ : 00 ▼	00 ▼ : 00 ▼
<input type="checkbox"/>	Sunday ▼	00 ▼ : 00 ▼	00 ▼ : 00 ▼



Wireless scheduling can save energy and increase the security of your network.

4. Use the “Enable” checkboxes to select schedule(s).
5. Specify a day, start time and end time for the schedule using the drop-down menus.
6. Click “Apply” to save the schedules or “Reset” to reset all values back to default.

IV-3-2. WPS

> WPS

Wi-Fi Protected Setup is a simple way to establish connections between WPS compatible devices. WPS can be activated on compatible devices by pushing a WPS button on the device or from within the device's firmware/configuration interface (known as PBC or "Push Button Configuration"). When WPS is activated in the correct manner and at the correct time for two compatible devices, they will automatically connect. "PIN code WPS" is a variation of PBC which includes the additional use of a PIN code between the two devices for verification.



Please refer to manufacturer's instructions for your other WPS device.

WPS	<input checked="" type="checkbox"/> Enable
-----	--

Apply

WPS	
Product PIN	58327142 <input type="button" value="Generate PIN"/>
Push-button WPS	<input type="button" value="Start"/>
WPS by PIN	<input type="text"/> <input type="button" value="Start"/>

WPS Security	
WPS Status	Not Configured <input type="button" value="Release"/>

WPS	Check/uncheck this box to enable/disable WPS functionality. WPS must be disabled when using MAC-RADIUS authentication (see IV-3-1-3-6 & IV-3-4).
------------	--

WPS	
Product PIN	Displays the WPS PIN code of the device, used for PIN code WPS. You will be required to enter this PIN code into another WPS device for PIN code WPS. Click "Generate PIN" to generate a new WPS PIN code.
Push-Button WPS	Click "Start" to activate WPS on the access point for approximately 2 minutes. This has the same effect as physically pushing the access point's WPS button.
WPS by PIN	Enter the PIN code of another WPS device and click "Start" to attempt to establish a WPS connection for approximately 2 minutes.

WPS Security	
WPS Status	WPS security status is displayed here. Click "Release" to clear the existing status.

Wireless 2.4GHz	
SSID	Displays the SSID name(s) for the specified frequency.
Security	Displays the security for the specified SSID.
Encryption	Displays the encryption type for the specified SSID. See IV-3. Wireless Settings

IV-3-3. RADIUS

RADIUS

The RADIUS menu allows you to configure the access point's external RADIUS server settings.

A RADIUS server provides user-based authentication to improve security and offer wireless client control – users can be authenticated before gaining access to a network.

The access point can utilize both a primary and secondary (backup) external RADIUS server for each of its wireless frequencies (2.4GHz & 5GHz)..



To use RADIUS servers, go to “Wireless Settings” → “Security” and select “MAC RADIUS Authentication” → “Additional Authentication” and select “MAC RADIUS Authentication” (see IV-3-1-3. & IV-3-2-3).

IV-3-3-1. RADIUS Settings

➤ Radius Settings

Configure the RADIUS server settings for 2.4GHz. Each frequency can use an internal or external RADIUS server.

RADIUS Server (2.4GHz)	
Primary RADIUS Server	
RADIUS Type	<input type="radio"/> Internal <input checked="" type="radio"/> External
RADIUS Server	<input type="text"/>
Authentication Port	<input type="text" value="1812"/>
Shared Secret	<input type="text"/>
Session Timeout	<input type="text" value="3600"/> second(s)
Accounting	<input checked="" type="radio"/> Enable <input type="radio"/> Disable
Accounting Port	<input type="text" value="1813"/>
Secondary RADIUS Server	
RADIUS Type	<input type="radio"/> Internal <input checked="" type="radio"/> External
RADIUS Server	<input type="text"/>
Authentication Port	<input type="text" value="1812"/>
Shared Secret	<input type="text"/>
Session Timeout	<input type="text" value="3600"/> second(s)
Accounting	<input checked="" type="radio"/> Enable <input type="radio"/> Disable
Accounting Port	<input type="text" value="1813"/>

RADIUS Server (5GHz)	
Primary RADIUS Server	
RADIUS Type	<input type="radio"/> Internal <input checked="" type="radio"/> External
RADIUS Server	<input type="text"/>
Authentication Port	<input type="text" value="1812"/>
Shared Secret	<input type="text"/>
Session Timeout	<input type="text" value="3600"/> second(s)
Accounting	<input checked="" type="radio"/> Enable <input type="radio"/> Disable
Accounting Port	<input type="text" value="1813"/>
Secondary RADIUS Server	
RADIUS Type	<input type="radio"/> Internal <input checked="" type="radio"/> External
RADIUS Server	<input type="text"/>
Authentication Port	<input type="text" value="1812"/>
Shared Secret	<input type="text"/>
Session Timeout	<input type="text" value="3600"/> second(s)
Accounting	<input checked="" type="radio"/> Enable <input type="radio"/> Disable
Accounting Port	<input type="text" value="1813"/>

RADIUS Type	Select “Internal” to use the access point’s built-in RADIUS server or “external” to use an external RADIUS server.
RADIUS Server	Enter the RADIUS server host IP address.
Authentication Port	Set the UDP port used in the authentication protocol of the RADIUS server. Value must be between 1 – 65535.
Shared Secret	Enter a shared secret/password between 1 – 99 characters in length. This should match the “MAC-RADIUS” password used in IV-3-1-3-6 or IV-3-2-3 .
Session Timeout	Set a duration of session timeout in seconds between 0 – 86400.
Accounting	Enable or disable RADIUS accounting.
Accounting Port	When accounting is enabled (above), set the UDP port used in the accounting protocol of the RADIUS server. Value must be between 1 – 65535.

IV-3-3-2. Internal Server

> Internal Server The access point features a built-in RADIUS server which can be configured as shown below used when “Internal” is selected for “RADIUS Type” in the “Wireless Settings” → “RADIUS” → “RADIUS Settings” menu.



To use RADIUS servers, go to “Wireless Settings” → “Security” and select “MAC RADIUS Authentication” → “Additional Authentication” and select “MAC RADIUS Authentication” (see IV-3-1-3. & IV-3-2-3).

Internal Server	
Internal Server	<input type="checkbox"/> Enable
EAP Internal Authentication	PEAP(MS-PEAP) ▼
EAP Certificate File Format	PKCS#12(*.pfx/*.p12)
EAP Certificate File	<input type="button" value="Upload"/>
Shared Secret	<input type="text"/>
Session-Timeout	<input type="text" value="3600"/> second(s)
Termination-Action	<input checked="" type="radio"/> Reauthentication (RADIUS-Request) <input type="radio"/> Not-Reauthentication (Default) <input type="radio"/> Not-Send

Internal Server	Check/uncheck to enable/disable the access point's internal RADIUS server.
EAP Internal Authentication	Select EAP internal authentication type from the drop down menu.
EAP Certificate File Format	Displays the EAP certificate file format: PCK#12(*.pfx/*.p12)
EAP Certificate File	Click "Upload" to open a new window and select the location of an EAP certificate file to use. If no certificate file is uploaded, the internal RADIUS server will use a self-made certificate.
Shared Secret	Enter a shared secret/password for use between the internal RADIUS server and RADIUS client. The shared secret should be 1 – 99 characters in length. This should match the "MAC-RADIUS" password used in IV-3-1-3-6 or IV-3-2-3 .
Session Timeout	Set a duration of session timeout in seconds between 0 – 86400.
Termination Action	Select a termination-action attribute: "Reauthentication" sends a RADIUS request to the access point, "Not-Reathentication" sends a default termination-action attribute to the access point, "Not-Send" no termination-action attribute is sent to the access point.

IV-3-3-3. RADIUS Accounts

> Radius Accounts The internal RADIUS server can authenticate up to 256 user accounts. The “RADIUS Accounts” page allows you to configure and manage users.

Radius Accounts

User Name

Example: EDIMAX-USER1, EDIMAX-USER2, EDIMAX-USER3, EDIMAX-USER4

Enter user name here

Add
Reset

User Registration List

Select	User Name	Password	Customize
<input type="checkbox"/>	EDIMAX	Not Configured	<div style="border: 1px solid #ccc; padding: 2px 5px; display: inline-block;">Edit</div>

Delete Selected

Delete All



Edit User Registration List

User Name	<input style="width: 90%;" type="text" value="EDIMAX"/> (4-16characters)
Password	<input style="width: 90%;" type="text"/> (6-32characters)

User Name	Enter the user names here, separated by commas.
Add	Click “Add” to add the user to the user registration list.
Reset	Clear text from the user name box.

Select	Check the box to select a user.
User Name	Displays the user name.
Password	Displays if specified user name has a password (configured) or not (not configured).
Customize	Click “Edit” to open a new field to set/edit a password for the specified user name (below).

Delete Selected	Delete selected user from the user registration list.
Delete All	Delete all users from the user registration list.

Edit User Registration List

User Name	Existing user name is displayed here and can be edited according to your preference.
Password	Enter or edit a password for the specified user.

IV-3-4. MAC Filter

> MAC Filter

Mac filtering is a security feature that can help to prevent unauthorized users from connecting to your access point.

This function allows you to define a list of network devices permitted to connect to the access point. Devices are each identified by their unique MAC address. If a device which is not on the list of permitted MAC addresses attempts to connect to the access point, it will be denied.



To enable MAC filtering, go to “Wireless Settings” → “2.4G Hz 11bgn” → “Security” → “Additional Authentication” and select “MAC Filter” (see IV-3-1-3).

The MAC address filtering table is displayed below:

Add MAC Addresses

Add
Reset

MAC Address Filtering Table

Select	MAC Address
<input type="checkbox"/>	FC:F8:AE:43:43:7E

Delete Selected
Delete All
Export

Add MAC Address

Enter a MAC address of computer or network device manually e.g. ‘aa-bb-cc-dd-ee-ff’ or enter multiple MAC addresses separated with

	commas, e.g. 'aa-bb-cc-dd-ee-ff,aa-bb-cc-dd-ee-gg'
Add	Click "Add" to add the MAC address to the MAC address filtering table.
Reset	Clear all fields.

MAC address entries will be listed in the "MAC Address Filtering Table". Select an entry using the "Select" checkbox.

Select	Delete selected or all entries from the table.
MAC Address	The MAC address is listed here.
Delete Selected	Delete the selected MAC address from the list.
Delete All	Delete all entries from the MAC address filtering table.
Export	Click "Export" to save a copy of the MAC filtering table. A new window will pop up for you to select a location to save the file.

IV-3-5. WMM

> WMM

Wi-Fi Multimedia (WMM) is a Wi-Fi Alliance interoperability certification based on the IEEE 802.11e standard, which provides Quality of Service (QoS) features to IEEE 802.11 networks. WMM prioritizes traffic according to four categories: background, best effort, video and voice.

WMM-EDCA Settings				
WMM Parameters of Access Point				
	CWMin	CWMax	AIFSN	TxOP
Back Ground	4	10	7	0
Best Effort	4	6	3	0
Video	3	4	1	94
Voice	2	3	1	47

WMM Parameters of Station				
	CWMin	CWMax	AIFSN	TxOP
Back Ground	4	10	7	0
Best Effort	4	10	3	0
Video	3	4	2	94
Voice	2	3	2	47

Configuring WMM consists of adjusting parameters on queues for different categories of wireless traffic. Traffic is sent to the following queues:

Background	Low Priority	High throughput, non time sensitive bulk data e.g. FTP
Best Effort	Medium Priority	Traditional IP data, medium throughput and delay.
Video	High Priority	Time sensitive video data with minimum time delay.
Voice	High Priority	Time sensitive data such as VoIP and streaming media with minimum time delay.

Queues automatically provide minimum transmission delays for video, voice, multimedia and critical applications. The values can further be adjusted manually:

CWMin	Minimum Contention Window (milliseconds): This value is input to the initial random backoff wait time algorithm for retry of a data frame transmission. The backoff wait time will be generated between 0 and this value. If the frame is not sent, the random backoff value is doubled until the value reaches the number defined by CWMax (below). The CWMin value must be lower than the CWMax value. The contention window scheme helps to avoid frame collisions and determine priority of frame transmission. A shorter window has a higher probability (priority) of transmission.
CWMax	Maximum Contention Window (milliseconds): This value is the upper limit to random backoff value doubling (see above).
AIFSN	Arbitration Inter-Frame Space (milliseconds): Specifies additional time between when a channel goes idle and the AP/client sends data frames. Traffic with a lower AIFSN value has a higher priority.
TxOP	Transmission Opportunity (milliseconds): The maximum interval of time an AP/client can transmit. This makes channel access more efficiently prioritized. A value of 0 means only one frame per transmission. A greater value effects higher priority.

IV-4. Management



 ***Screenshots displayed are examples. The information shown on your screen will vary depending on your configuration.***

IV-4-1. Admin

 You can change the password used to login to the browser-based configuration interface here. It is advised to do so for security purposes.

 ***If you change the administrator password, please make a note of the new password. In the event that you forget this password and are unable to login to the browser based configuration interface, see I-5. Reset for how to reset the access point.***

Account to Manage This Device

Administrator Name	<input type="text" value="admin"/>
Administrator Password	<input type="password" value="....."/> (4-32 Characters)
	<input type="password" value="....."/> (Confirm)

Advanced Settings

Product Name	<input type="text" value="AP00AABBCCDD10"/>
Management Protocol	<input checked="" type="checkbox"/> HTTP <input type="checkbox"/> TELNET <input type="checkbox"/> SNMP
SNMP Version	<input type="text" value="v1/v2c"/> ▼
SNMP Get Community	<input type="text" value="public"/>
SNMP Set Community	<input type="text" value="private"/>
SNMP Trap	<input type="text" value="Disabled"/> ▼
SNMP Trap Community	<input type="text" value="public"/>
SNMP Trap Manager	<input type="text"/>

Account to Manage This Device

Administrator Name	Set the access point's administrator name. This is used to log in to the browser based configuration interface and must be between 4-16 alphanumeric characters (case sensitive).
Administrator Password	Set the access point's administrator password. This is used to log in to the browser based configuration interface and must be between 4-32 alphanumeric characters (case sensitive).

Advanced Settings

Product Name	Edit the product name according to your preference consisting of 1-32 alphanumeric characters. This name is used for reference purposes.
Management Protocol	Check/uncheck the boxes to enable/disable specified management interfaces (see below).

	When SNMP is enabled, complete the SNMP fields below.
SNMP Version	Select SNMP version appropriate for your SNMP manager.
SNMP Get Community	Enter an SNMP Get Community name for verification with the SNMP manager for SNMP-GET requests.
SNMP Set Community	Enter an SNMP Set Community name for verification with the SNMP manager for SNMP-SET requests.
SNMP Trap	Enable or disable SNMP Trap to notify SNMP manager of network errors.
SNMP Trap Community	Enter an SNMP Trap Community name for verification with the SNMP manager for SNMP-TRAP requests.
SNMP Trap Manager	Specify the IP address or sever name (2-128 alphanumeric characters) of the SNMP manager.

HTTP

Internet browser HTTP protocol management interface

TELNET

Client terminal with telnet protocol management interface

SNMP

Simple Network Management Protocol. SNMPv1, v2 & v3 protocol supported. SNMPv2 can be used with community based authentication. SNMPv3 uses user-based security model (USM) architecture.

IV-4-2. Date and Time

> Date and Time

You can configure the time zone settings of your access point here. The date and time of the device can be configured manually or can be synchronized with a time server.

Date and Time Settings	
Local Time	2012 <input type="text"/> Year Jan <input type="text"/> Month 1 <input type="text"/> Day 0 <input type="text"/> Hours 00 <input type="text"/> Minutes 00 <input type="text"/> Seconds
<input type="button" value="Acquire Current Time from Your PC"/>	
NTP Time Server	
Use NTP	<input type="checkbox"/> Enable
Server Name	<input type="text"/>
Update Interval	24 <input type="text"/> (Hours)
Time Zone	
Time Zone	(GMT) Greenwich Mean Time: Dublin, Edinburgh, Lisbon, London <input type="text"/>

Date and Time Settings	
Local Time	Set the access point's date and time manually using the drop down menus.
Acquire Current Time from your PC	Click "Acquire Current Time from Your PC" to enter the required values automatically according to your computer's current time and date.

NTP Time Server	
Use NTP	The access point also supports NTP (Network Time Protocol) for automatic time and date setup.

Server Name	Enter the host name or IP address of the time server if you wish.
Update Interval	Specify a frequency (in hours) for the access point to update/synchronize with the NTP server.

Time Zone	
Time Zone	Select the time zone of your country/ region. If your country/region is not listed, please select another country/region whose time zone is the same as yours.

IV-4-3. Syslog Server

> Syslog Server

The system log can be sent to a server or to attached USB storage.

Syslog Server Settings	
Transfer Logs	<input type="checkbox"/> Enable Syslog Server <input type="text"/>
Syslog E-mail Settings	
E-mail Logs	<input type="checkbox"/>
E-mail Subject	<input type="text"/>
SMTP Server Address	<input type="text"/>
SMTP Server Port	<input type="text"/>
Sender E-mail	<input type="text"/>
Receiver E-mail	<input type="text"/>
Authentication	Disable ▾

Syslog Server Settings	
Transfer Logs	Check/uncheck the box to enable/disable the use of a syslog server, and enter a host name, domain or IP address for the server, consisting of up to 128 alphanumeric characters.

Syslog E-mail Settings	
E-mail Logs	Check the box to enable/disable e-mail logs.
E-mail Subject	Specify the subject line of log emails.
SMTP Server Address	Specify the SMTP server address used to send log emails.
SMTP Server Port	Specify the SMTP server port used to send log emails.
Sender E-mail	Specify the sender email address.
Receiver E-mail	Specify the email to receive log emails.
Authentication	Disable or select authentication type: SSL or TLS. When using SSL or TLS, enter the username and password.

IV-4-4. Ping Test

> Ping Test

The access point includes a built-in ping test function. Ping is a computer network administration utility used to test whether a particular host is reachable across an IP network and to measure the round-trip time for sent messages.

The screenshot shows a web interface for a ping test. At the top, there is a dark header with the text 'Ping Test'. Below the header, there is a form with a text input field labeled 'Destination Address' and an 'Execute' button to its right. Underneath the input field, the word 'Result' is displayed in red text, followed by a large, empty rectangular box intended for the test results.

Destination Address	Enter the address of the host.
Execute	Click execute to ping the host.

IV-4-5. I'm Here

> I'm Here

The access point features a built-in buzzer which can sound on command using the “I’m Here” page. This is useful for network administrators and engineers working in complex network environments to locate the access point.

Duration of Sound

Duration of Sound

(1-300 seconds)

 ***The buzzer is loud!***

Duration of Sound	Set the duration for which the buzzer will sound when the “Sound Buzzer” button is clicked.
Sound Buzzer	Activate the buzzer sound for the above specified duration of time.

IV-4-6. Operation Mode

> Operation Mode

The access point can function in three different modes. Set the operation mode of the access point here. AP mode is a standalone access point, AP controller mode acts as the designated master of the AP array, and Managed AP mode acts as a slave AP within the AP array. Refer back to **Overview** and **Edimax Pro NMS I. Product Information** for more help.



In Managed AP mode some functions of the access point will be disabled in this user interface and must be set using Edimax Pro NMS on the AP Controller.



In AP Controller Mode the access point will switch to the Edimax Pro NMS user interface.

Operation Mode	
	<p>AP Mode is a standard access point in a wireless network.</p> <p>AP Controller Mode is the master of an AP array and controls all other managed APs (below) using Edimax Pro NMS.</p> <p>Managed AP mode is an AP which is part of the AP array and is managed by the Controller AP.</p>

IV-5. Advanced

Information Network Settings Wireless Settings Management **Advanced**



Screenshots displayed are examples. The information shown on your screen will vary depending on your configuration.

IV-5-1. LED Settings

> LED Settings

The access point's LEDs can be manually enabled or disabled according to your preference.

LED Settings

Power LED

On Off

Power LED

Select on or off.

IV-5-2. Update Firmware

> Update Firmware

The “Firmware” page allows you to update the system firmware to a more recent version. Updated firmware versions often offer increased performance and security, as well as bug fixes. You can download the latest firmware from the Edimax website.

Firmware Location

Update firmware from
 a file on your PC

Update firmware from PC

Firmware Update File

Choose File

No file chosen

Update



Do not switch off or disconnect the access point during a firmware upgrade, as this could damage the device.

Update Firmware From	Select “a file on your PC” to upload firmware from your local computer.
Firmware Update File	Click “Choose File” to open a new window to locate and select the firmware file in your computer.
Update	Click “Update” to upload the specified firmware file to your access point.

IV-5-3. Save/Restore Settings

> Save/Restore Settings The access point’s “Save/Restore Settings” page enables you to save/backup the access point’s current settings as a file to your local computer or a USB device attached to the access point, and restore the access point to previously saved settings.

Save / Restore Settings	
Using Device	Select “Using your PC” to save the access point’s settings to your local computer.

Save Settings to PC	
Save Settings	Click “Save” to save settings and a new window will open to specify a location to save the settings file. You can also check the “Encrypt the configuration file with a password” box and enter a password to protect the file in the field underneath, if you wish.

Restore Settings from PC**Restore Settings**

Click the browse button to find a previously saved settings file on your computer, then click “Restore” to replace your current settings. If your settings file is encrypted with a password, check the “Open file with password” box and enter the password in the field underneath.

IV-5-4. Factory Default

> Factory Default

If the access point malfunctions or is not responding, then it is recommended that you reboot the device (see **IV-5.5**) or reset the device back to its factory default settings. You can reset the access point back to its default settings using this feature if the location of the access point is not convenient to access the reset button.

This will restore all settings to factory defaults.

Factory Default

Factory Default

Click “Factory Default” to restore settings to the factory default. A pop-up window will appear and ask you to confirm.



After resetting to factory defaults, please wait for the access point to reset and restart.

IV-5-5. Reboot

> Reboot If the access point malfunctions or is not responding, then it is recommended that you reboot the device or reset the access point back to its factory default settings (see **IV-5-4**). You can reboot the access point remotely using this feature.

This will reboot the product. Your settings will not be changed. Click "Reboot" to reboot the product now.

Reboot

Reboot	Click "Reboot" to reboot the device. A countdown will indicate the progress of the reboot.
---------------	--

I. Product Information

Edimax Pro Network Management Suite (NMS) supports the central management of a group of access points, otherwise known as an AP Array. NMS can be installed on one access point and support up to 8 Edimax Pro access points with no additional wireless controller required, reducing costs and facilitating efficient remote AP management.

Access points can be deployed and configured according to requirements, creating a powerful network architecture which can be easily managed and expanded in the future, with an easy to use interface and a full range of functionality – ideal for small and mid-sized office environments. A secure WLAN can be deployed and administered from a single point, minimizing cost and complexity.

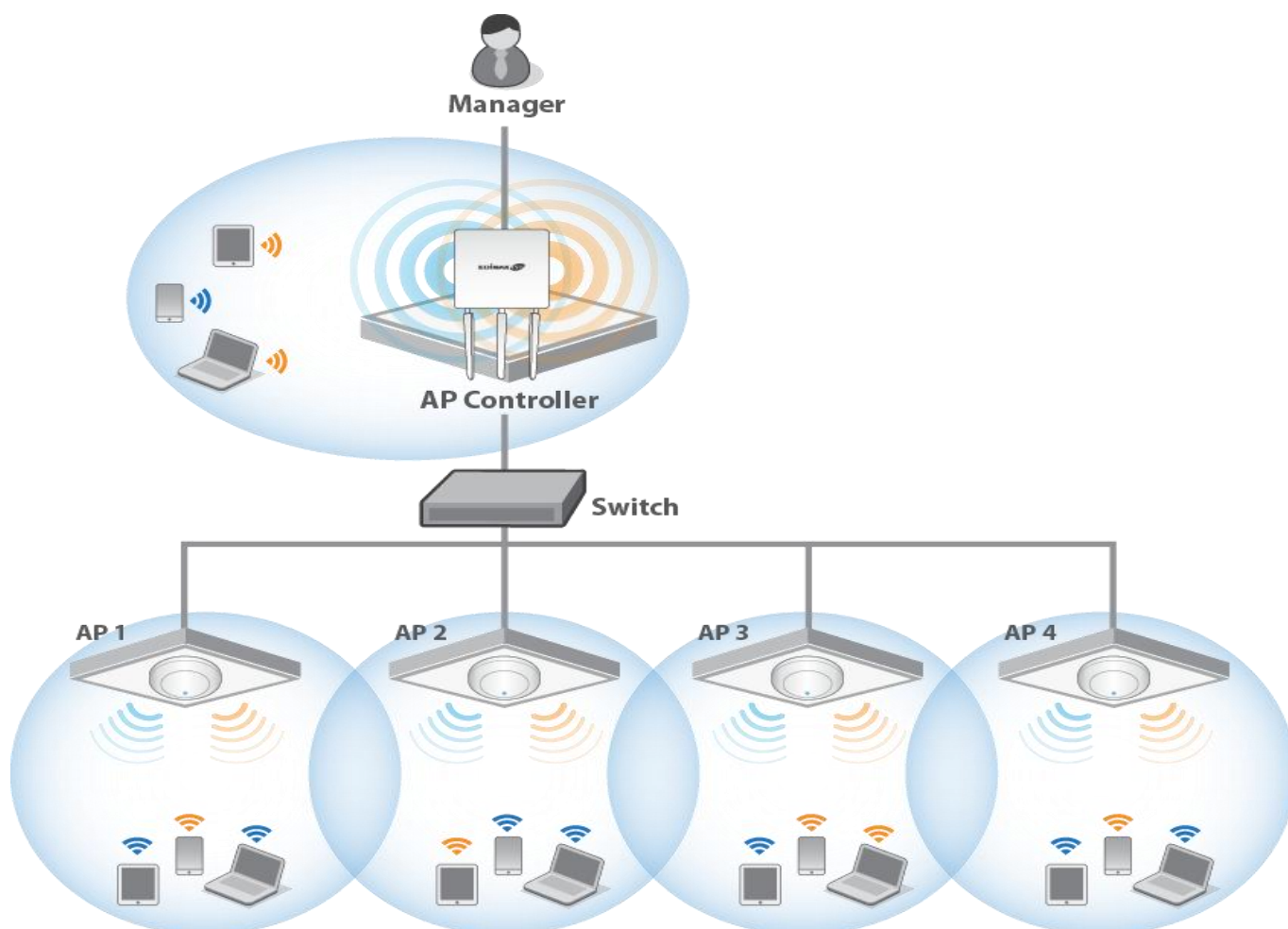

II. Quick Setup

Edimax Pro NMS is simple to setup. An overview of the system is shown below:

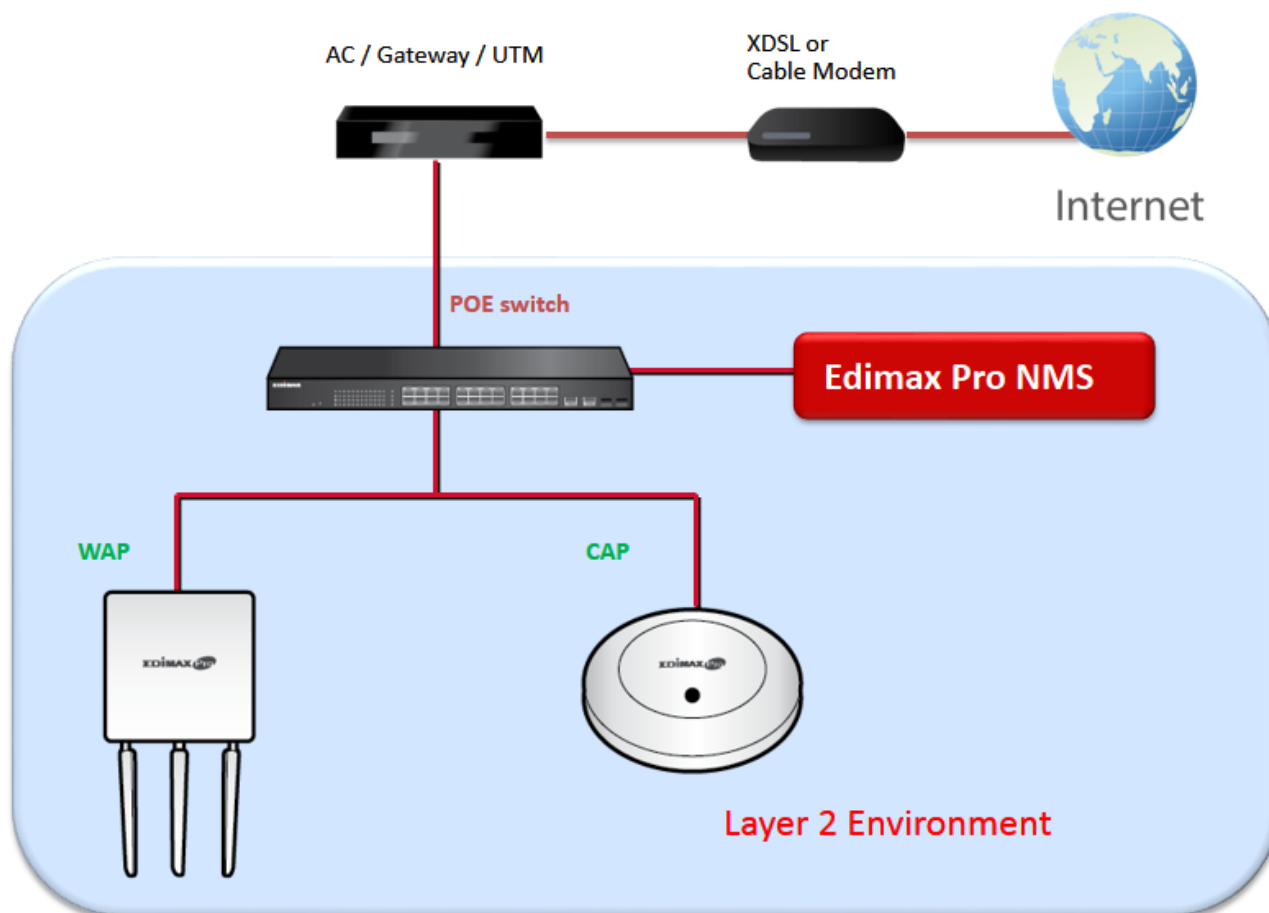

One AP (access point) is designated as the AP Controller (master) and other connected Edimax Pro APs are automatically designated as Managed APs (slaves). Using Edimax Pro NMS you can monitor, configure and manage all Managed APs (up to 8) from the single AP Controller.

Follow the steps below:

 **Ensure you have the latest firmware from the Edimax website for your Edimax Pro products.**

- 1.** Connect all APs to an Ethernet or PoE switch which is connected to a gateway/router.

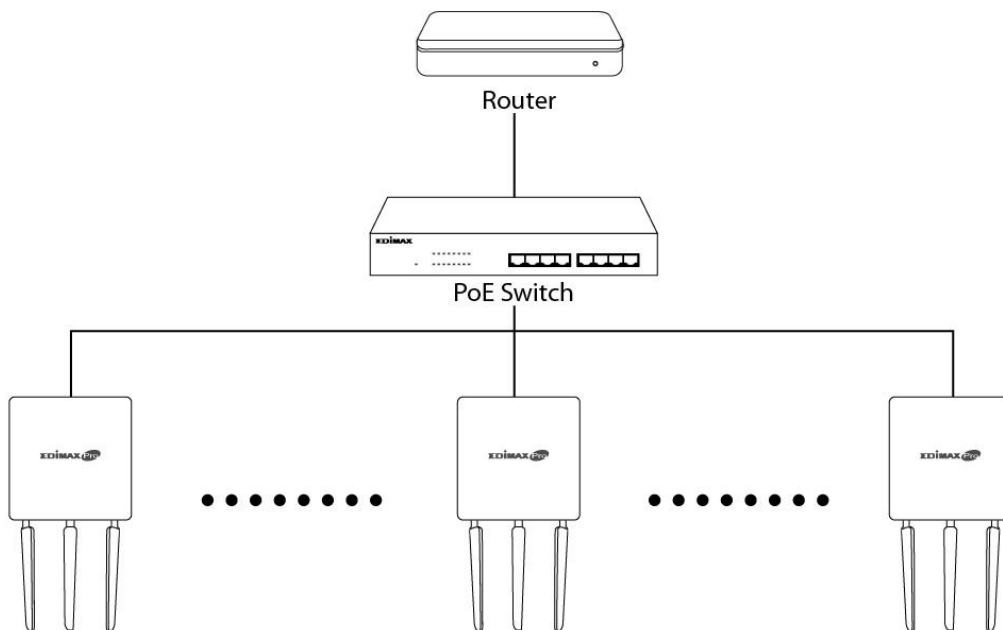

- 2.** Ensure all APs are powered on and check LEDs.

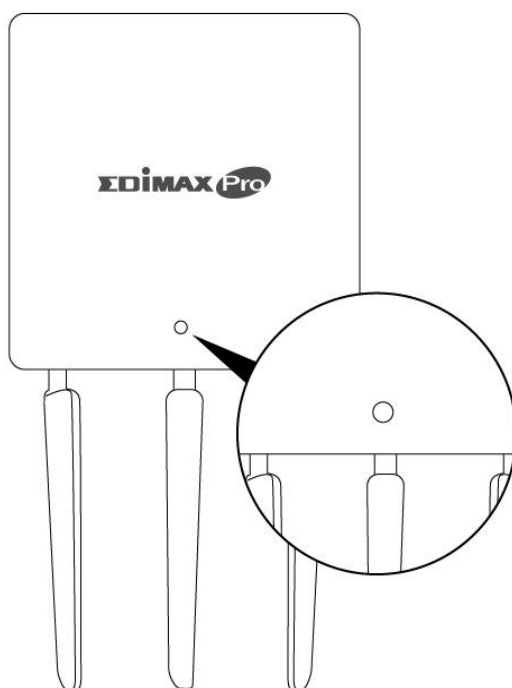

- 3.** Designate one AP as the AP Controller which will manage all other connected APs (up to 8).

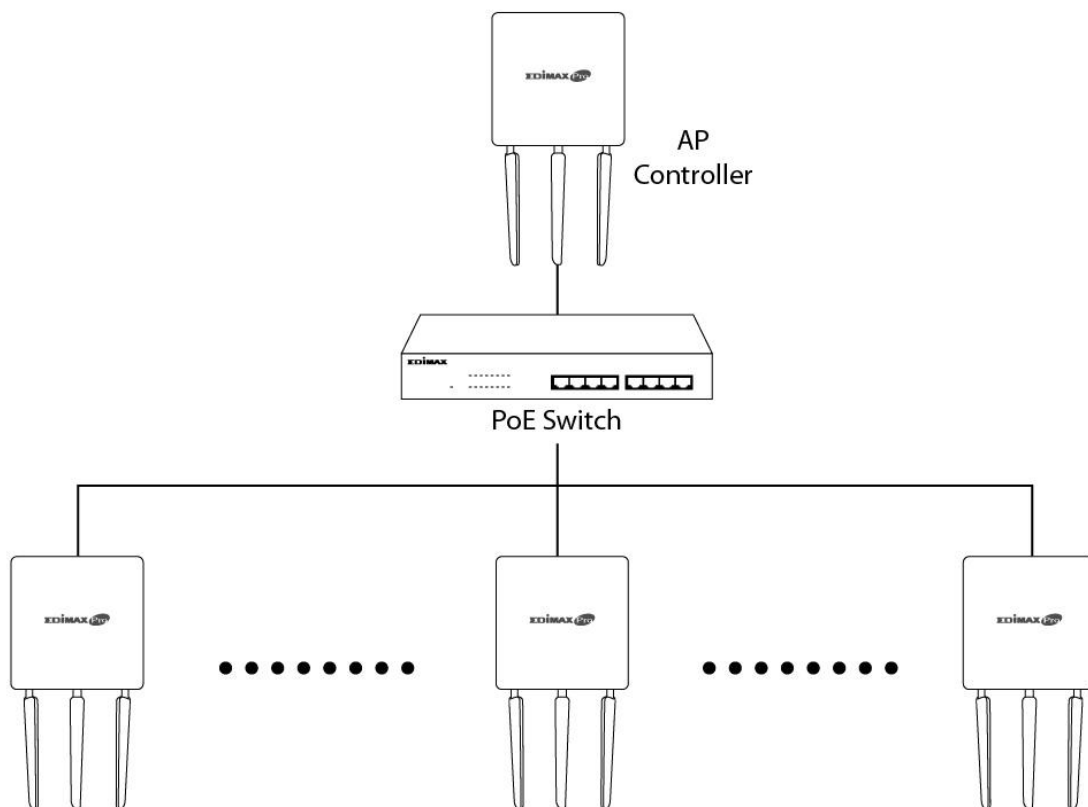

- 4.** Connect a computer to the designated AP Controller using an Ethernet cable.

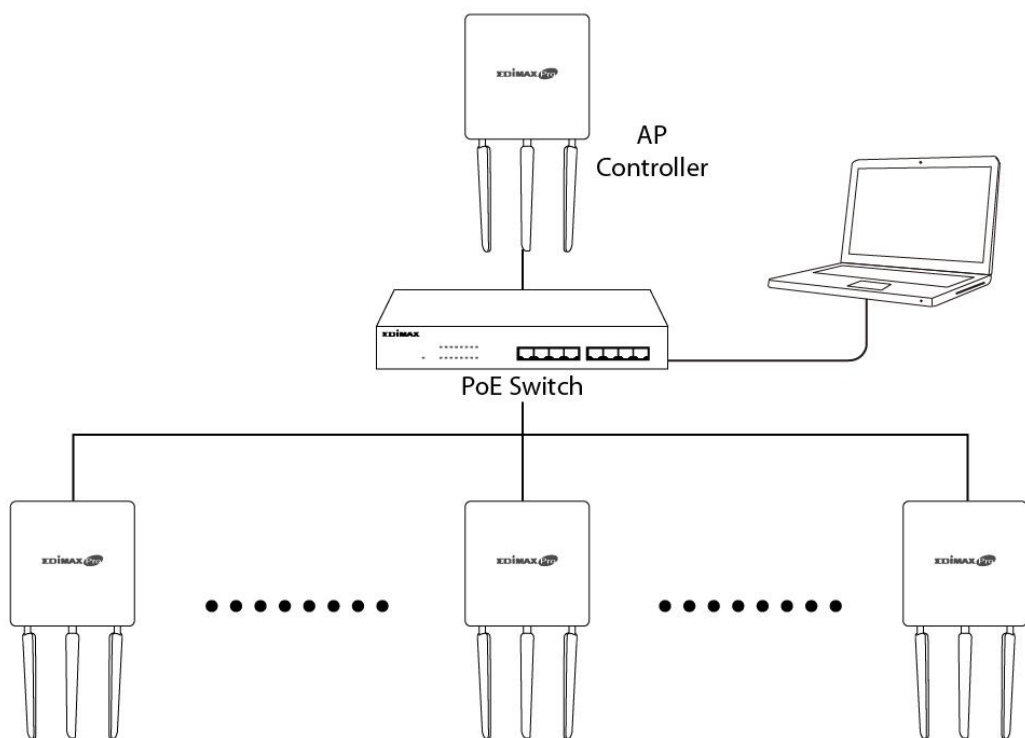

5. Open a web browser and enter the AP Controller's IP address in the address field. The default IP address is **192.168.2.2**

 **Your computer's IP address must be in the same subnet as the AP Controller. Refer to V-1. Configuring your IP Address for help.**



 **If you changed the AP Controller's IP address, or if your gateway/router uses a DHCP server, ensure you enter the correct IP address. Refer to your gateway/router's settings.**

6. Enter the username & password to login. The default username & password are **admin** & **1234**.
7. You will arrive at the Edimax Pro NMS Dashboard. Go to **“Management”** → **“Operation Mode”** and select **“AP Controller Mode”** from the drop down menu.

The screenshot shows the Edimax Pro NMS interface. At the top, there is a navigation bar with 'Home | Logout | Global (English)'. Below that is a main menu with 'CAP1200', 'Information', 'Network Settings', 'Wireless Settings', and 'Management'. The 'Management' tab is selected, indicated by a blue arrow and a circled '1'. On the left, a sidebar menu lists 'Management' sub-items: 'Admin', 'Date and Time', 'Syslog Server', 'Ping Test', 'I'm Here', and 'Operation Mode'. The 'Operation Mode' item is highlighted in red, with a blue arrow and a circled '2' pointing to it. The main content area shows the 'Operation Mode' configuration page. A dropdown menu is open, showing options: 'AP Mode', 'AP Mode', 'AP Controller Mode' (highlighted in blue), and 'Managed AP mode'. A blue arrow and a circled '3' point to the 'AP Controller Mode' option. At the bottom right of the configuration area, there are 'Apply' and 'Cancel' buttons.

8. Click “Apply” to save the settings.

This is a close-up of the 'Operation Mode' configuration page. The dropdown menu is set to 'AP Controller Mode'. A blue arrow points from the right towards the 'Apply' and 'Cancel' buttons.

9. Edimax Pro NMS includes a wizard to quickly setup the SSID & security for Managed APs. Click “Wizard” in the top right corner to begin.

This is a close-up of the top right corner of the interface. A blue arrow points to the 'Wizard' link in the navigation bar, which also includes 'Home | Logout | Global (English)'. The 'Wizard' link is highlighted in blue.

10. Follow the instructions on-screen to complete **Steps 1, 2 & 3** and click “**Finish**” to save the settings.

Step 1 : Welcome Step 2 : AP Discovery Step 3 : Setup WLAN

1 To start, please power on the managed APs and plug into the same internet network with this AP Controller.

This Setup Wizard will guide you through a basic procedure to configure NMS system.

Next >> Cancel Rescan

Step 1 : Welcome Step 2 : AP Discovery Step 3 : Setup WLAN

2 Search Managed AP(s)

Match whole words

<input type="checkbox"/>	MAC Address	Device Name	Model	IP Address	Status
<input checked="" type="checkbox"/>	74:DA:38:03:B5:30	AP74DA3803B530	WAP1750	192.168.222.222	
<input checked="" type="checkbox"/>	74:DA:38:00:00:B4	AP74DA380000B4	WAP1750	192.168.222.221	
<input type="checkbox"/>	74:DA:38:00:20:40		WAP1750		

Next >> Cancel

Step 1 : Welcome Step 2 : AP Discovery Step 3 : Setup WLAN

3 Settings

SSID

Security Key

Guest Network Enable Disable

Guest SSID

Security Key

5GHz Settings

Clone 2.4GHz Settings

SSID

Security Key

Guest Network Enable Disable

Guest SSID



If any of your Managed APs are not found during Step 2 AP Discovery, reset the Managed AP to its factory default settings.

- 11.** Your AP Controller & Managed APs should be fully functional. Use the top menu to navigate around Edimax Pro NMS.



Use ***Dashboard, Zone Plan, NMS Monitor & NMS Settings*** to configure Managed APs.

Use ***Local Network & Local Settings*** to configure your AP Controller.

III. Software Layout

The top menu features 7 panels: *Dashboard*, *Zone Plan*, *NMS Monitor*, *NMS Settings*, *Local Network*, *Local Settings* & *Toolbox*.

Dashboard



WAP1750
Dashboard
Zone Plan
NMS Monitor
NMS Settings
Local Network
Local Settings
Toolbox

Auto Refresh Time : 1 minute 30 seconds Disable 48

System Information

Product Name	WAP1750
Host Name	AP74DA3803EC1A
MAC Address	74-DA-38-03-EC-1A
IP Address	192.168.222.220
Firmware Version	0.9.12
System Time	2012/01/01 04:50:51
Uptime	0 day 04:50:53

Managed AP

Search Match whole words

Index	MAC Address	Device Name	Model	IP Address	2.4G Channel	5G Channel	Clients	Status	Action
1	74-DA-38-03-B5-30	AP74DA3803B53		192.168.222.22	0	0	0	●	⊘ ⓘ ⊕ ⊖ ↺ ↻
2	74-DA-38-00-00-B4	AP74DA380000B		192.168.222.21	0	0	0	●	⊘ ⓘ ⊕ ⊖ ↺ ↻

Managed AP Group

Search Match whole words

Group Name	MAC Address	Device Name	Model	IP Address	Clients	Status	Action
System Default (2)							
	74-DA-38-03-B5-30	AP74DA3803B530		192.168.222.222	0	●	⊘ ⓘ ⊕ ⊖ ↺ ↻
	74-DA-38-00-00-B4	AP74DA380000B4		192.168.222.221	0	●	⊘ ⓘ ⊕ ⊖ ↺ ↻

Active Clients

Search Match whole words

Index	Client MAC Address	AP MAC Address	WLAN	Radio	Signal(%)	Connected Time	Idle Time	Tx(KB)	Rx(KB)	Vendor
Empty										

The **Dashboard** panel displays an overview of your network and key system information, with quick links to access configuration options for Managed APs and Managed AP groups. Each panel can be refreshed, collapsed or moved according to your preference.

Zone Plan

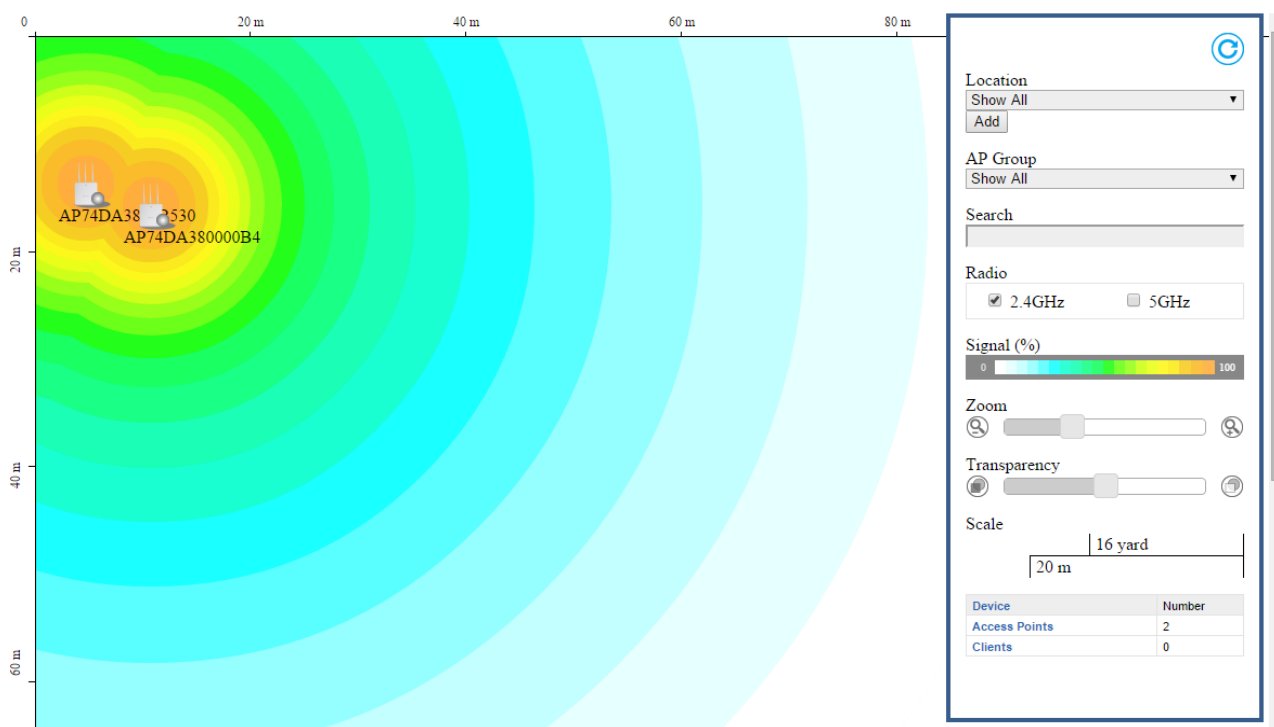
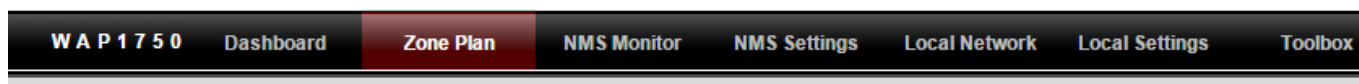

Zone Plan displays a customizable live map of Managed APs for a visual representation of your network coverage. Each AP icon can be moved around the map, and a background image can be uploaded for user-defined location profiles using **NMS Settings** → **Zone Edit**. Options can be configured using the menu on the right side and signal strength is displayed for each AP.

NMS Monitor



W A P 1 7 5 0 Dashboard Zone Plan **NMS Monitor** NMS Settings Local Network Local Settings Toolbox

- > Access Point
 - > Managed AP**
 - Managed AP Group
 - > WLAN
 - Active WLAN
 - Active WLAN Group
 - > Clients
 - Active Clients
 - > Rogue Devices
 - > Information
 - All Events/Activities
 - Monitoring

Managed AP

Search Match whole words

Index	MAC Address	Device Name	Model	IP Address	2.4G Channel	5G Channel	Clients	Status	Action
1	74:DA:38:03:B5:30	AP74DA3803B530		192.168.222.222	0	0	0		
2	74:DA:38:00:00:E4	AP74DA380000E4		192.168.222.221	0	0	0		

The **NMS Monitor** panel provides more detailed monitoring information about the AP Array than found on the Dashboard, grouped according to categories in the menu down the left side.

NMS Settings



Access Point

- > WLAN
- > RADIUS
- > Access Control
- > Guest Network
- > Zone Edit
- > Firmware Upgrade
- > Advanced
 - System Security
 - Date and Time

Access Point

Search Match whole words

<input type="checkbox"/>	MAC Address	Device Name	Model	AP Group	2.4G Channel	5G Channel	2.4G TX Power	5G TX Power	Status	Action
<input type="checkbox"/>	74-DA-38-03-B5-30	AP74DA3803B530		System Default	0	0	Full	Full	<input type="radio"/>	<input type="button" value="⊘"/>
<input type="checkbox"/>	74-DA-38-00-00-B4	AP74DA380000B4		System Default	0	0	Full	Full	<input type="radio"/>	<input type="button" value="⊘"/>

Refresh Edit Delete Selected Delete All

Access Point Group

Search Match whole words

<input type="checkbox"/>	Group Name	AP Members	2.4G WLAN Profile	5G WLAN Profile	2.4G Guest Network Profile	5G Guest Network Profile	RADIUS Profile	Access Control Profile
<input type="checkbox"/>	System Default	2	EDIMAX_SSID_GROUP_SF	EDIMAX_SSID_GROUP_SF	EDIMAX_GUEST_SSID_GROUP_SF	EDIMAX_GUEST_SSID_GROUP_SF	Disabled	Disabled

Add Edit Clone Delete Selected Delete All

Access Point Settings

Auto Approve Enable Disable

Apply

NMS Settings provides extensive configuration options for the AP Array. You can manage each access point, assign access points into groups, manage WLAN, RADIUS & guest network settings as well as upgrade firmware across multiple access points. The Zone Plan can also be configured using “Zone Edit”.

Local Network



> Network Settings

- > LAN-side IP Address
- LAN Port Settings
- VLAN
- > 2.4GHz 11bgn
 - Basic
 - Advanced
 - Security
 - WDS
- > 5GHz 11ac 11an
 - Basic
 - Advanced
 - Security
 - WDS
- > WPS
- > RADIUS
 - RADIUS Settings
 - Internal Server
 - RADIUS Accounts
- > MAC Filter
- > WMM

LAN-side IP Address

IP Address Assignment	Static IP Address ▾
IP Address	192.168.222.220
Subnet Mask	255.255.255.0
Default Gateway	192.168.222.1
Primary DNS Address	0.0.0.0
Secondary DNS Address	0.0.0.0

Local Network settings are for your AP Controller. You can configure the IP address and DHCP server of the AP Controller in addition to 2.4GHz & 5GHz Wi-Fi and security, with WPS, RADIUS server, MAC filtering and WMM settings also available.

Local Settings

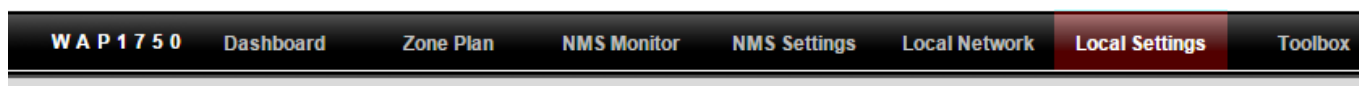

The screenshot displays the 'Local Settings' interface for the WAP 1750. On the left, a sidebar menu lists various settings categories: Operation Mode (highlighted), Network Settings, System Information, Wireless Clients, Wireless Monitor, Log, Management, Admin, Date and Time, Syslog Server, I'm Here, Advanced, LED Settings, Update Firmware, Save/Restore Settings, Factory Default, and Reboot. The main content area is titled 'Operation Mode' and features a dropdown menu currently set to 'AP Controller Mode'. Below the dropdown are 'Apply' and 'Cancel' buttons.

Local Settings are for your AP Controller. You can set the operation mode and view network settings (clients and logs) specifically for the AP Controller, as well as other management settings such as date/time, admin accounts, firmware and reset.

Toolbox

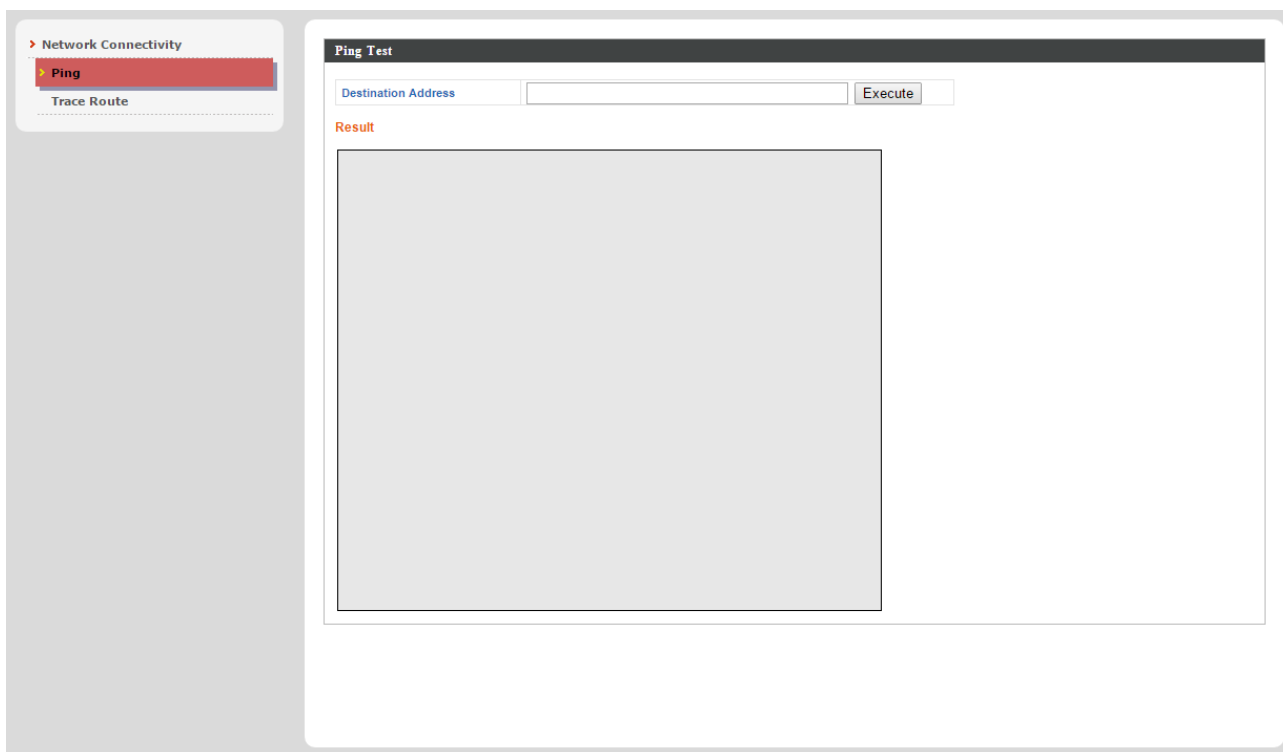
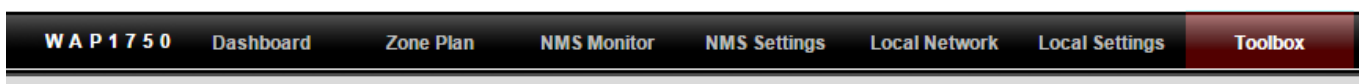

The Toolbox panel provides a network diagnostic tools: *ping* and *traceroute*.

IV. Features

Descriptions of the functions of each main panel *Dashboard, Zone Plan, NMS Monitor, NMS Settings, Local Network, Local Settings & Toolbox* can be found below. When using Edimax NMS, click “Apply” to save changes:



 **Screenshots displayed are examples. The information shown on your screen will vary depending on your configuration.**

IV-1. LOGIN, LOGOUT & RESTART

 **It is recommended that you login to the AP Controller to make configurations to Managed APs.**

LOGIN

1. Connect a computer to the designated AP Controller using an Ethernet cable:

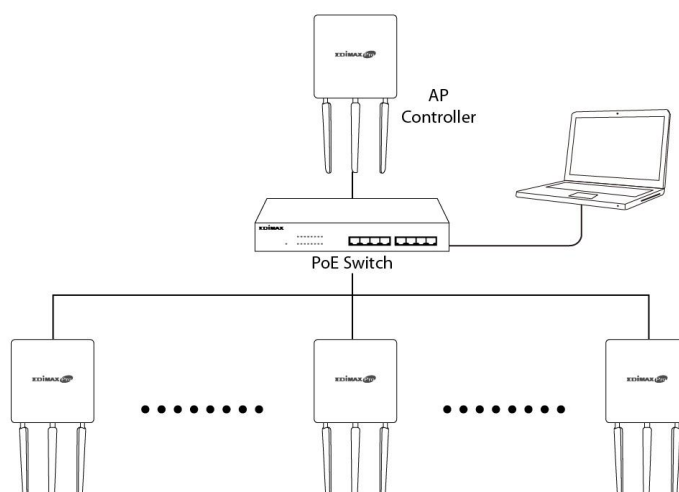

2. Open a web browser and enter the AP Controller’s IP address in the address field. The default IP address is **192.168.2.2**

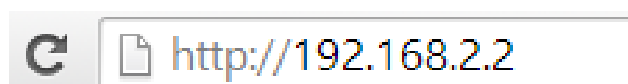

 **Your computer's IP address must be in the same subnet as the AP Controller. Refer to V-1. Configuring your IP Address for more help.**

 **If you changed the AP Controller's IP address, or if your gateway/router uses a DHCP server, ensure you enter the correct IP address. Refer to your gateway/router's settings.**

 **If using a DHCP server on the network, it is advised to use your DHCP server's settings to assign the AP Controller a static IP address.**

3. Enter the username & password to login. The default username & password are **admin** & **1234**.

LOGOUT

To logout from Edimax NMS, click "Logout" in the top right corner:

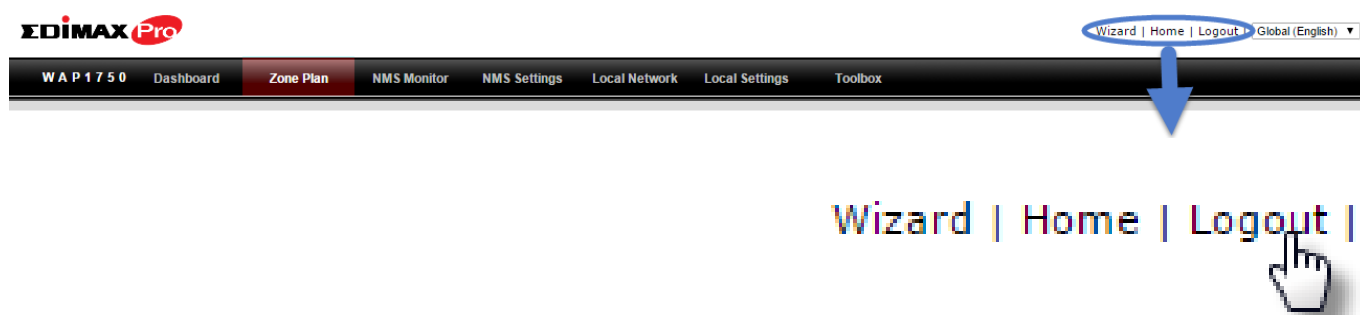

RESTART

You can restart your AP Controller or any Managed AP using Edimax NMS. To restart your AP Controller go to **Local Settings** → **Advanced** → **Reboot** and click "Reboot".

This will reboot the product. Your settings will not be changed. Click "Reboot" to reboot the product now.

Reboot

To restart Managed APs click the Restart icon for the specified AP on the Dashboard:



IV-2. DASHBOARD

The dashboard displays an overview of your AP array:

Auto Refresh Time : ● 1 minute ○ 30 seconds ○ Disable 43

System Information

Product Name	WAP1750
Host Name	AP74DA3803EC1A
MAC Address	74-DA-38-03-EC-1A
IP Address	192.168.222.220
Firmware Version	0.9.12
System Time	2012/01/01 20:46:14
Uptime	0 day 20:46:19

Managed AP

Search Match whole words

Index	MAC Address	Device Name	Model	IP Address	2.4G Channel	5G Channel	Clients	Status	Action
1	74-DA-38-03-B5-30	AP74DA3803B530		192.168.222.222	0	0	0		
2	74-DA-38-00-00-B4	AP74DA380000B4		192.168.222.221	0	0	0		

Devices Information

Device	Number
Access Points	2
Client Devices	0
Rogue Devices	0

Managed AP Group

Search Match whole words

Group Name	MAC Address	Device Name	Model	IP Address	Clients	Status	Action
System Default (2)							
	74-DA-38-03-B5-30	AP74DA3803B530		192.168.222.222	0		
	74-DA-38-00-00-B4	AP74DA380000B4		192.168.222.221	0		

Active Clients

Search Match whole words

Index	Client MAC Address	AP MAC Address	WLAN	Radio	Signal(%)	Connected Time	Idle Time	Tx(KB)	Rx(KB)	Vendor
Empty										





Use the blue icons above to refresh or collapse each panel in the dashboard. Click and drag to move a panel to suit your preference. You can set the dashboard to auto-refresh every 1 minute, 30 seconds or disable auto-refresh:

Auto Refresh Time : ● 1 minute ○ 30 seconds ○ Disable



IV-2-1. System Information

System Information displays information about the AP Controller: *Product Name (model), Host Name, MAC Address, IP Address, Firmware Version, System Time and Uptime (time the access point has been on).*

System Information  	
Product Name	WAP1750
Host Name	AP74DA3803EC1A
MAC Address	74:DA:38:03:EC:1A
IP Address	192.168.222.220
Firmware Version	0.9.12
System Time	2012/01/01 20:49:25
Uptime	0 day 20:49:31

IV-2-2. Devices Information

Devices Information is a summary of the number of all devices in the local network: *Access Points, Clients Connected, and Rogue (unidentified) Devices.*

Devices Information  	
Device	Number
Access Points	2
Client Devices	0
Rogue Devices	0

IV-2-3. Managed AP

Managed AP displays information about each Managed AP in the local network: *Index (reference number), MAC Address, Device Name, Model, IP Address, 2.4GHz & 5GHz Wireless Channel Number, No. of Clients connected to each access point, and Status (connected, connecting or disconnected).*

Index	MAC Address	Device Name	Model	IP Address	2.4G Channel	5G Channel	Clients	Status	Action
1	74:DA:38:03:B5:30	AP74DA3803B530		192.168.222.222	0	0	0		
2	74:DA:38:00:00:B4	AP74DA380000B4		192.168.222.221	0	0	0		

The **search** function can be used to locate a specific Managed AP. Type in the search box and the list will update:



The **Status** icon displays *grey* (disconnected), *yellow* (connecting) or *green* (connected) for each Managed AP.

Each Managed AP has “**Action**” icons with the following functions:



1. Disallow

Remove the Managed AP from the AP array and disable connectivity.

2. Edit

*Edit various settings for the Managed AP (refer to **IV-5-1. Access Point**).*

3. Blink LED

The Managed AP's LED will flash temporarily to help identify & locate access points.

4. Buzzer

The Managed AP's buzzer will sound temporarily to help identify & locate access points.

5. Network Connectivity

Go to the “Network Connectivity” panel to perform a ping or traceroute.

6. Restart

Restarts the Managed AP.

IV-2-4. Managed AP Group

Managed APs can be grouped according to your requirements. **Managed AP Group** displays information about each Managed AP group in the local network: *Group Name, MAC Address, Device Name, Model, IP Address, 2.4GHz & 5GHz Wireless Channel Number, No. of Clients connected to each access point, and Status (connected or disconnected).*

To edit Managed AP Groups go to **NMS Settings → Access Point** (refer to **IV-5-1. Access Point**).

Group Name	MAC Address	Device Name	Model	IP Address	Clients	Status	Action
System Default (2)							
	74:DA:38:03:B5:30	AP74DA3803B530		192.168.222.222	0		
	74:DA:38:00:00:B4	AP74DA380000B4		192.168.222.221	0		

The search function can be used to locate a specific Managed AP Group. Type in the search box and the list will update:

Search Match whole words

The **Status** icon displays *grey* (disconnected), *yellow* (connecting) or *green* (connected) for each individual Managed AP.

Each Managed AP has “**Action**” icons with the following functions:



1. Disallow

Remove the Managed AP from the AP array and disable connectivity.

2. Edit

Edit various settings for the Managed AP (refer to IV-5-1. Access Point)

3. Blink LED

The Managed AP's LED will flash temporarily to help identify & locate access points.

4. Buzzer

The Managed AP's buzzer will sound temporarily to help identify & locate access points.

5. Network Connectivity

Go to the "Network Connectivity" panel to perform a ping or traceroute.

6. Restart

Restarts the Managed AP.

IV-2-5. Active Clients

Active Clients displays information about each client in the local network: *Index (reference number), Client MAC Address, Device Name, Model, IP Address, 2.4GHz & 5GHz Wireless Channel Number, No. of Clients connected to each access point, and Status (on or off).*

Index	Client MAC Address	AP MAC Address	WLAN	Radio	Signal(%)	Connected Time	Idle Time	Tx(KB)	Rx(KB)	Vender
Empty										

The search function can be used to locate a specific client. Type in the search box and the list will update:

Search Match whole words

IV-3. ZONE PLAN

The Zone Plan can be fully customized to match your network environment. You can move the AP icons and select different location images (upload location images in **NMS Settings → Zone Edit**) to create a visual map of your AP array.

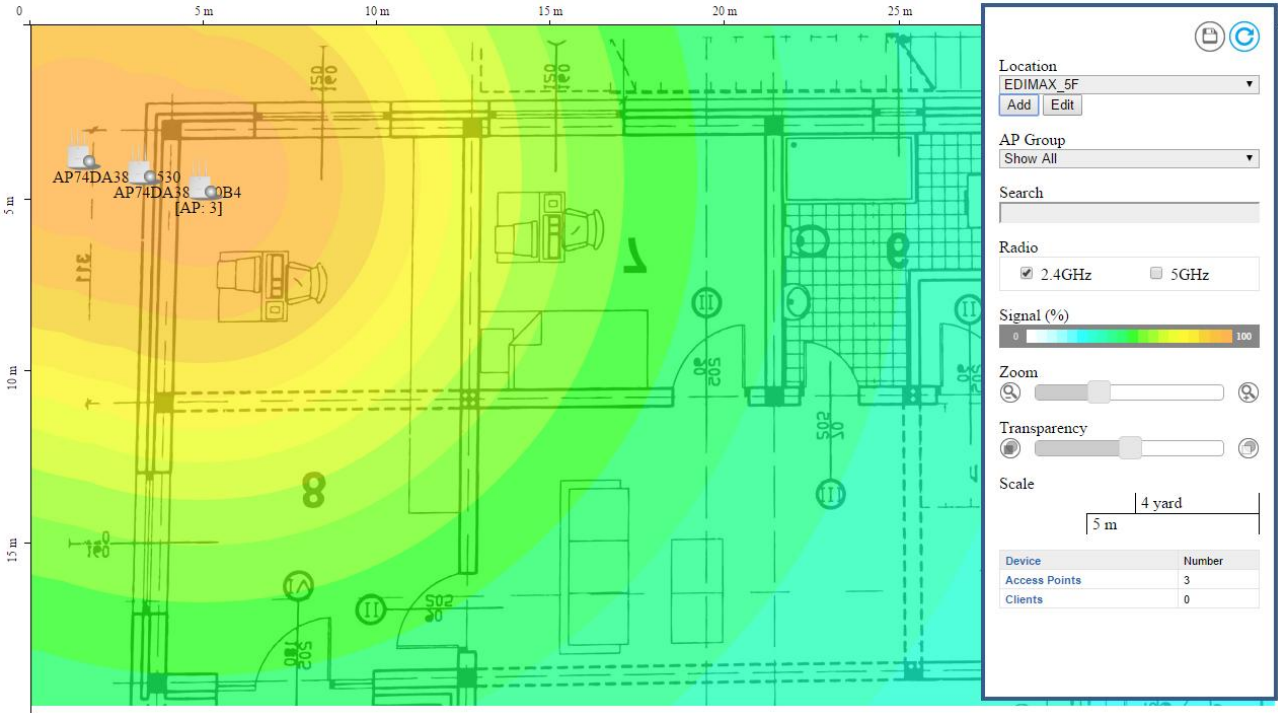

Use the menu on the right side to make adjustments and mouse-over an AP icon in the zone map to see more information. Click an AP icon in the zone map to select it and display action icons:

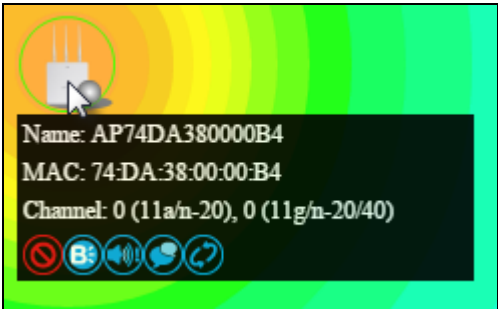

Click and drag an AP icon to move the icon around the zone map. The signal strength for each AP is displayed according to the “Signal” key in the menu on the right side:

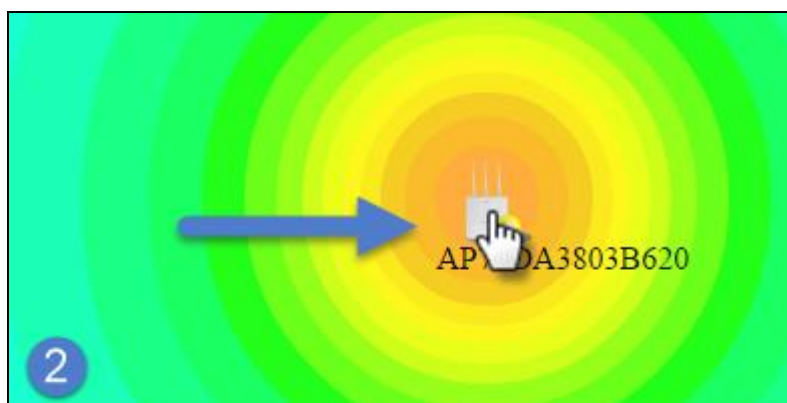
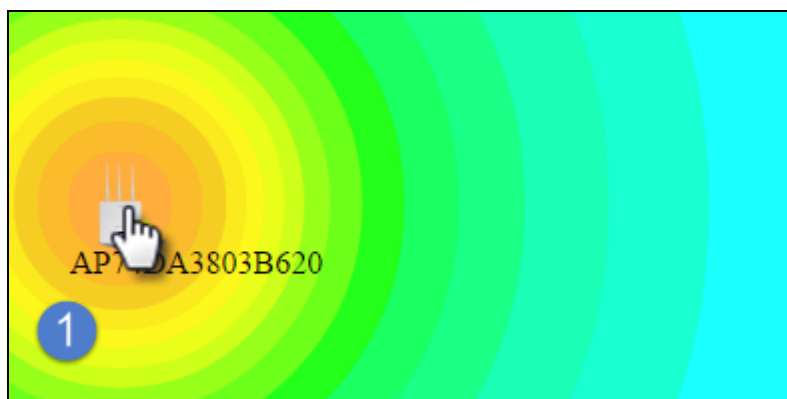

Location	Select a pre-defined location from the drop down menu. When you upload a location image in NMS Settings → Zone Edit , it will be available for selection here.
AP Group	You can select an AP Group to display in the zone map. Edit AP Groups in NMS Settings → Access Point .
Search	Use the search box to quickly locate an AP.
Radio	Use the checkboxes to display APs according to 2.4GHz or 5GHz wireless radio frequency.
Signal	Signal strength key for the signal strength display around each AP in the zone map.
Zoom	Use the slider to adjust the zoom level of the map.
Transparency	Use the slider to adjust the transparency of location images.
Scale	Zone map scale.
Device/Number	Displays number and type of devices in the zone map.

IV-4. NMS MONITOR

IV-4-1. Access Point

IV-4-1-1. Managed AP

Displays information about each Managed AP in the local network: *Index (reference number), MAC Address, Device Name, Model, IP Address, 2.4GHz & 5GHz Wireless Channel Number, No. of Clients connected to each access point, and Status (connected, connecting or disconnected).*





Index	MAC Address	Device Name	Model	IP Address	2.4G Channel	5G Channel	Clients	Status	Action
1	74:DA:38:03:B5:30	AP74DA3803B530		192.168.222.222	0	0	0		
2	74:DA:38:00:00:B4	AP74DA380000B4		192.168.222.221	0	0	0		

The **search** function can be used to locate a specific Managed AP. Type in the search box and the list will update:

Search Match whole words

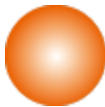
The **Status** icon displays the status of each Managed AP.

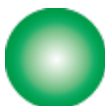
Status Icons			
Icon	Color	Status	Definition
	Grey	Disconnected	Managed AP is disconnected. <i>Please check the network connection and ensure the Managed AP is in the same IP subnet as the AP Controller.</i>
	Red	Authentication Failed Or Incompatible NMS Version	System security must be the same for all access points in the AP array. <i>Please check security settings (refer to IV-5-8-1. System Security).</i> Access points must use the same version of Edimax NMS: the managed AP will not be able to make configurations. <i>Please</i>

			<i>use the AP Controller's firmware upgrade function (refer to IV-5-7. Firmware Upgrade).</i>
	Orange	Configuring or Upgrading	<i>Please wait while the Managed AP makes configurations or while the firmware is upgrading.</i>
	Yellow	Connecting	<i>Please wait while Managed AP is connecting.</i>
	Green	Connected	<i>Managed AP is connected.</i>
	Blue	Waiting for Approval	<i>Managed AP is waiting for approval. Refer to IV-5-1. Access Point: Auto Approval. Note: Eight Managed APs are supported. Additional APs will display this status until an existing Managed AP is removed.</i>

Each Managed AP has “**Action**” icons with the following functions:



1. Disallow

Remove the Managed AP from the AP array and disable connectivity.

1. Edit

*Edit various settings for the Managed AP (refer to **IV-5-1. Access Point**).*

2. Blink LED

The Managed AP's LED will flash temporarily to help identify & locate access points.

3. Buzzer

The Managed AP's buzzer will sound temporarily to help identify & locate access points.

4. Network Connectivity

Go to the “Network Connectivity” panel to perform a ping or traceroute.

5. Restart

Restarts the Managed AP.

IV-4-1-2. Managed AP Group

Managed APs can be grouped according to your requirements. Managed AP Group displays information about each Managed AP group in the local network: *Group Name, MAC Address, Device Name, Model, IP Address, 2.4GHz & 5GHz Wireless Channel Number, No. of Clients connected to each access point, and Status (connected or disconnected).*

To edit Managed AP Groups go to **NMS Settings → Access Point** (refer to **IV-5-1. Access Point**).

Group Name	MAC Address	Device Name	Model	IP Address	Clients	Status	Action
System Default (2)							
	74:DA:38:03:B5:30	AP74DA3803B530		192.168.222.222	0		
	74:DA:38:00:00:B4	AP74DA380000B4		192.168.222.221	0		

The search function can be used to locate a specific Managed AP Group. Type in the search box and the list will update:

Search Match whole words

The **Status** icon displays *grey* (disconnected), *red* (authentication failed/incompatible NMS version), *orange* (upgrading firmware), *yellow* (connecting), *green* (connected) or *blue* (waiting for approval) for each individual Managed AP. Refer to **IV-4-1-1. Managed AP: Status Icons** for full descriptions.

Each Managed AP has “**Action**” icons with the following functions:



2. Disallow

Remove the Managed AP from the AP array and disable connectivity.

3. Edit

*Edit various settings for the Managed AP (refer to **IV-5-1. Access Point**).*

4. Blink LED

The Managed AP's LED will flash temporarily to help identify & locate access points.

5. Buzzer

The Managed AP's buzzer will sound temporarily to help identify & locate access points.

6. Network Connectivity

Go to the "Network Connectivity" panel to perform a ping or traceroute.

7. Restart

Restarts the Managed AP.

IV-4-2. WLAN

IV-4-2-1. Active WLAN

Displays information about each SSID in the AP Array: *Index (reference number), Name/SSID, VLAN ID, Authentication, Encryption, IP Address and Additional Authentication.*

To configure encryption and VLANs for Managed APs go to **NMS Settings → WLAN.**

The search function can be used to locate a specific SSID. Type in the search box and the list will update:

Search Match whole words

Active WLAN					
Index	Name/ESSID	VLAN ID	Authentication	Encryption	Additional Authentication
1	matt2.4	1	WPA2PSK	WPAPSK	No additional authentication
2	matt5	1	WPA2PSK	WPAPSK	No additional authentication

IV-4-2-2. Active WLAN Group

WLAN groups can be created according to your preference. Active WLAN Group displays information about WLAN group: *Group Name, Name/SSID, VLAN ID, Authentication, Encryption, IP Address and Additional Authentication.*

The search function can be used to locate a specific Active WLAN Group. Type in the search box and the list will update:

Search Match whole words

Group Name	Name/ESSID	VLAN ID	Authentication	Encryption	Additional Authentication
Default (0)					
Empty					
WLAN Group 2 (1)					
	matt2.4	1	WPA2PSK	AES	No additional authentication
WLAN Group 3 (1)					
	matt5	1	WPA2PSK	AES	No additional authentication

IV-4-3. Clients

IV-4-3-1. Active Clients

Displays information about clients currently connected to the AP Array: *Index (reference number), Client MAC Address, AP MAC Address, WLAN (SSID), Radio (2.4GHz or 5GHz), Signal Strength received by Client, Connected Time, Idle Time, Tx & Rx (Data transmitted and received by Client in KB), and the Vendor of the client device.*

You can set or disable the auto-refresh time for the client list or click “Refresh” to manually refresh.

The search function can be used to locate a specific client. Type in the search box and the list will update:

Search Match whole words

Refresh time

Auto Refresh time: 1 Minute 30 seconds Disable

Manual Refresh:

Active Clients ⊞ ⊟

Search: Match whole words

Index	Client MAC Address	AP MAC Address	WLAN	Radio	Signal(%)	Connected Time	Idle Time	Tx(KB)	Rx(KB)	Vender
1	6C:88:14:70:C2:14	74:DA:38:00:00:24	WIZARD_TEST5	5GHz	100	3 min 33 secs	4320	17.974	627.154	Intel Corporate
2	B4:52:7E:84:DB:5B	00:AA:BB:CC:DD:22	WIZARD_TEST1	2.4GHz	100	6 min 53 secs	120	8.554	46.607	Sony Mobile Communications AB

IV-4-4. Rogue Devices

Rogue access point detection can identify any unauthorized access points which may have been installed in the network.

Click “Start” to scan for rogue devices:



Unknown Rogue Devices displays information about rogue devices discovered during the scan: *Index (reference number), Channel, SSID, MAC Address, Security, Signal Strength, Type, Vendor and Action.*

The search function can be used to locate a known rogue device. Type in the search box and the list will update:

Search: Match whole words

Rogue Devices

Scan:

Unknown Rogue Devices

Search: Match whole words

Index	Channel	SSID	MAC Address	Security	Signal (%)	Type	Vendor	Action
No Rogue Device								

Known Rogue Devices

Search: Match whole words

IV-4-5. Information

IV-4-5-1. All Events/Activities

Displays a log of time-stamped events for each access point in the Array – use the drop down menu to select an access point and view the log.

Select AP:

```
2012/01/01 00:03:57: Managed AP(74:DA:38:03:B6:20) was disconnected
2012/01/01 00:08:25: Managed AP(74:DA:38:03:B6:20) was disconnected
2012/01/01 00:12:49: Managed AP(74:DA:38:03:B6:20) was disconnected
2012/01/01 00:17:17: Managed AP(74:DA:38:03:B6:20) was disconnected
2012/01/01 00:21:44: Managed AP(74:DA:38:03:B6:20) was disconnected
2012/01/01 00:26:11: Managed AP(74:DA:38:03:B6:20) was disconnected
2012/01/01 00:30:36: Managed AP(74:DA:38:03:B6:20) was disconnected
2012/01/01 00:35:03: Managed AP(74:DA:38:03:B6:20) was disconnected
2012/01/01 00:39:27: Managed AP(74:DA:38:03:B6:20) was disconnected
2012/01/01 00:43:55: Managed AP(74:DA:38:03:B6:20) was disconnected
2012/01/01 00:48:22: Managed AP(74:DA:38:03:B6:20) was disconnected
```

IV-4-5-2. Monitoring

Displays graphical monitoring information about access points in the Array for 2.4GHz & 5GHz: *Traffic Tx (data transmitted in MB), Traffic Rx (data received in MB), No. of Clients, Wireless Channel, Tx Power (wireless radio power), CPU Usage and Memory Usage.*

Use the drop down menus to select an access point and date.

You can set or disable the auto-refresh time for the data:

Auto Refresh Time : 1 minute 30 seconds Disable 35

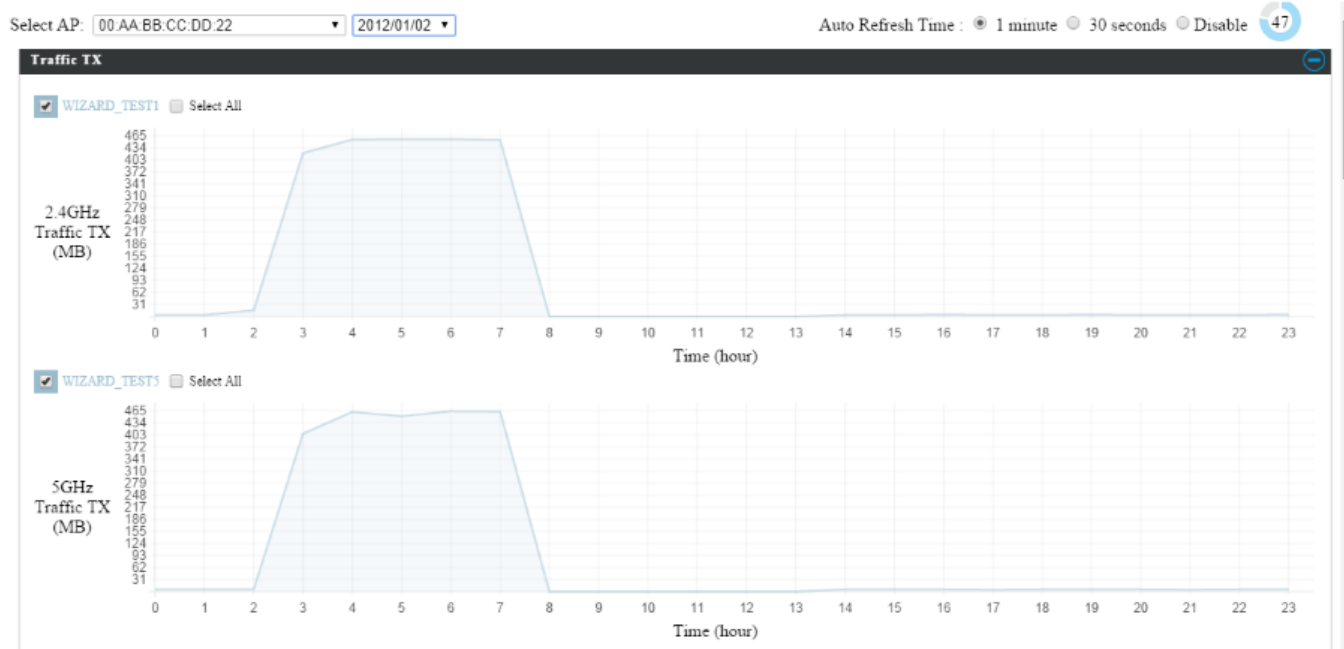

IV-5. NMS Settings

IV-5-1. Access Point

Displays information about each access point and access point group in the local network and allows you to edit access points and edit or add access point groups.

The **search** function can be used to locate an access point or access point group. Type in the search box and the list will update:

Search Match whole words

Access Point

Search Match whole words

<input type="checkbox"/>	MAC Address	Device Name	Model	AP Group	2.4G Channel	5G Channel	2.4G TX Power	5G TX Power	Status	Action
<input type="checkbox"/>	74:DA:38:03:B6:20	AP74DA3803B620	WAP1750	AP Group 02	11	36	Full	Full	●	

Refresh Edit Delete Selected Delete All

Access Point Group

Search Match whole words

<input type="checkbox"/>	Group Name	AP Members	2.4G WLAN Profile	5G WLAN Profile	2.4G Guest Network Profile	5G Guest Network Profile	RADIUS Profile	Access Control Profile
<input type="checkbox"/>	System Default	0	Default	Default	Disabled	Disabled		Default
<input type="checkbox"/>	AP Group 02	1	WLAN Group 2	WLAN Group 3	Disabled	Disabled		Default



Add Edit Clone Delete Selected Delete All

Access Point Settings

Auto Approve Enable Disable

Apply

The **Status** icon displays *grey* (disconnected), *red* (authentication failed/incompatible NMS version), *orange* (upgrading firmware), *yellow* (connecting), *green* (connected) or *blue* (waiting for approval) for each individual Managed AP. Refer to **IV-4-1-1. Managed AP: Status Icons** for full descriptions.

The **“Action”** icons enable you to allow or disallow an access point:  

Select an access point or access point group using the check-boxes and click “**Edit**” to make configurations, or click “**Add**” to add a new access point group:



The **Access Point Settings** panel can enable or disable Auto Approve for all Managed APs. When enabled, Managed APs will automatically join the AP Array with the Controller AP. When disabled, Managed APs must be manually approved to join the AP Array with the Controller AP.

Access Point Settings

Auto Approve Enable Disable

Apply

Access Point Settings	
Auto Approve	Enable or disable Auto Approve for all Managed APs.

To manually approve a Managed AP, use the *allow* “Action” icon for the specified access point:

Edit Access Point

Configure your selected access point on your LAN. You can set the access point as a DHCP client or specify a static IP address for your access point, and assign the access point to an AP group, as well as edit 2.4GHz & 5GHz wireless radio settings. An events log is displayed at the bottom of the page.

You can also use **Profile Settings** to assign the access point to WLAN, Guest Network, RADIUS and Access Control groups independently from Access Point Group settings.

Check the “**Override Group Settings**” box to use different individual settings for access points assigned to AP Groups:



Basic Settings	
Name	AP74DA3803B530
Description	
MAC Address	74:DA:38:03:B5:30
AP Group	System Default
IP Address Assignment	
	<input type="checkbox"/> Override Group Setting Static IP Address
IP Address	192.168.222.101
Subnet Mask	255.255.255.0
Default Gateway	User-Defined 192.168.222.2
Primary DNS	User-Defined 192.168.222.3
Secondary DNS	User-Defined 192.168.222.4

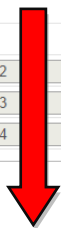

IP Address Assignment	<input checked="" type="checkbox"/> Override Group Setting DHCP Client
IP Address	192.168.222.101
Subnet Mask	255.255.255.0
Default Gateway	From DHCP 192.168.222.2
Primary DNS	From DHCP 192.168.222.3
Secondary DNS	From DHCP 192.168.222.4

Basic Settings	
Name	Edit the access point name. The default name is AP + MAC address.
Description	Enter a description of the access point for reference e.g. 2 nd Floor Office.
MAC Address	Displays MAC address.
AP Group	Use the drop down menu to assign the AP to an AP Group. You can edit AP Groups from the NMS Settings → Access Point page.
IP Address Assignment	Select "DHCP Client" for your access point to be assigned a dynamic IP address from your router's DHCP server, or select "Static IP" to manually specify a static/fixed IP address for your access point (below). Check the box "Override Group Setting" if the AP is a member of an AP Group and you wish to use a different setting than the AP Group setting.
IP Address	Specify the IP address here. This IP address will be assigned to your access point and will replace the default IP address.
Subnet Mask	Specify a subnet mask. The default value is 255.255.255.0

Default Gateway	For DHCP users, select “From DHCP” to get default gateway from your DHCP server or “User-Defined” to enter a gateway manually. For static IP users, the default value is blank.
Primary DNS	DHCP users can select “From DHCP” to get primary DNS server’s IP address from DHCP or “User-Defined” to manually enter a value. For static IP users, the default value is blank.
Secondary DNS	DHCP users can select “From DHCP” to get secondary DNS server’s IP address from DHCP or “User-Defined” to manually enter a value. For static IP users, the default value is blank.

Radio Settings

	Radio B/G/N (2.4 GHz)	Radio A/N (5.0 GHz)
Wireless	<input type="checkbox"/> Override Group Setting Enable	<input type="checkbox"/> Override Group Setting Enable
Band	<input type="checkbox"/> Override Group Setting 11b/g/n	<input type="checkbox"/> Override Group Setting 11a/n/ac
Auto Pilot	<input type="checkbox"/> Override Group Setting Enable	<input type="checkbox"/> Override Group Setting Enable
Auto Pilot Range	<input type="checkbox"/> Override Group Setting Ch 1 - 11	<input type="checkbox"/> Override Group Setting
Auto Pilot Interval	<input type="checkbox"/> Override Group Setting Half day <input type="checkbox"/> Change channel even if clients are connected	<input type="checkbox"/> Override Group Setting Half day <input type="checkbox"/> Change channel even if clients are connected
Channel Bandwidth	<input type="checkbox"/> Override Group Setting Auto	<input type="checkbox"/> Override Group Setting Auto 80/40/20 MHz
BSS BasicRateSet	<input type="checkbox"/> Override Group Setting all	<input type="checkbox"/> Override Group Setting all

Advanced Settings

	Radio B/G/N (2.4 GHz)	Radio A/N (5.0 GHz)
Contention Slot	<input type="checkbox"/> Override Group Setting Short	<input type="checkbox"/> Override Group Setting Short
Preamble Type	<input type="checkbox"/> Override Group Setting Short	<input type="checkbox"/> Override Group Setting Short
Guard Interval	<input type="checkbox"/> Override Group Setting Short GI	<input type="checkbox"/> Override Group Setting Short GI
802.11n Protection	<input type="checkbox"/> Override Group Setting Enable	<input type="checkbox"/> Override Group Setting Enable
DTIM Period	<input type="checkbox"/> Override Group Setting 255 (1-255)	<input type="checkbox"/> Override Group Setting 255 (1-255)
RTS Threshold	<input type="checkbox"/> Override Group Setting 2347 (1-2347)	<input type="checkbox"/> Override Group Setting 2347 (1-2347)
Fragment Threshold	<input type="checkbox"/> Override Group Setting 2346 (256-2346)	<input type="checkbox"/> Override Group Setting 2346 (256-2346)
Multicast Rate	<input type="checkbox"/> Override Group Setting Auto	<input type="checkbox"/> Override Group Setting Auto
Tx Power	<input type="checkbox"/> Override Group Setting 100%	<input type="checkbox"/> Override Group Setting 100%
Beacon Interval	<input type="checkbox"/> Override Group Setting 100 (40-1000 ms)	<input type="checkbox"/> Override Group Setting 100 (40-1000 ms)
Station idle timeout	<input type="checkbox"/> Override Group Setting 300 (30-65535 seconds)	<input type="checkbox"/> Override Group Setting 300 (30-65535 seconds)

Radio Settings	
Wireless	Enable or disable the access point’s 2.4GHz or 5GHz wireless radio. When disabled, no SSIDs on that frequency will be active.
Band	Select the wireless standard used for the access point. Combinations of 802.11b, 802.11g, 802.11n & 802.11ac can be selected.
Auto Pilot	Enable/disable auto channel selection. Auto

	channel selection will automatically set the wireless channel for the access point's 2.4GHz or 5GHz frequency based on availability and potential interference. When disabled, select a channel manually.
Auto Pilot Range	Select a range from which the auto channel setting (above) will choose a channel.
Auto Pilot Interval	Specify a frequency for how often the auto channel setting will check/reassign the wireless channel. Check/uncheck the "Change channel even if clients are connected" box according to your preference.
Channel Bandwidth	Set the channel bandwidth or use Auto (automatically select based on interference level).
BSS BasicRateSet	Set a Basic Service Set (BSS) rate: this is a series of rates to control communication frames for wireless clients.

These settings are for experienced users only. Please do not change any of the values on this page unless you are already familiar with these functions.



Changing these settings can adversely affect the performance of your access point.

Advanced Settings	
Contention Slot	Select "Short" or "Long" – this value is used for contention windows in WMM (see IV-6-7. WMM).
Preamble Type	Set the wireless radio preamble type. The preamble type in 802.11 based wireless communication defines the length of the CRC (Cyclic Redundancy Check) block for communication between the access point and roaming wireless adapters. The default value is "Short Preamble".
Guard Interval	Set the guard interval. A shorter interval can improve performance.

802.11g Protection	Enable/disable 802.11g protection, which increases reliability but reduces bandwidth (clients will send Request to Send (RTS) to access point, and access point will broadcast Clear to Send (CTS), before a packet is sent from client.)
802.11n Protection	Enable/disable 802.11n protection, which increases reliability but reduces bandwidth (clients will send Request to Send (RTS) to access point, and access point will broadcast Clear to Send (CTS), before a packet is sent from client.)
DTIM Period	Set the DTIM (delivery traffic indication message) period value of the wireless radio. The default value is 1.
RTS Threshold	Set the RTS threshold of the wireless radio. The default value is 2347.
Fragment Threshold	Set the fragment threshold of the wireless radio. The default value is 2346.
Multicast Rate	Set the transfer rate for multicast packets or use the "Auto" setting.
Tx Power	Set the power output of the wireless radio. You may not require 100% output power. Setting a lower power output can enhance security since potentially malicious/unknown users in distant areas will not be able to access your signal.
Beacon Interval	Set the beacon interval of the wireless radio. The default value is 100.
Station idle timeout	Set the interval for keepalive messages from the access point to a wireless client to verify if the station is still alive/active.

Profile Settings				
	Radio B/G/N (2.4 GHz)		Radio A/N (5.0 GHz)	
WLAN Group	<input type="checkbox"/> Override Group Setting	WLAN Group 2 ▼	<input type="checkbox"/> Override Group Setting	WLAN Group 3 ▼
Guest Network Group	<input type="checkbox"/> Override Group Setting	Disable ▼	<input type="checkbox"/> Override Group Setting	Disable ▼
RADIUS Group	<input type="checkbox"/> Override Group Setting	▼		
Access Control Group	<input type="checkbox"/> Override Group Setting	Default ▼		

Profile Settings	
WLAN Group	Assign the access point's 2.4GHz or 5GHz

	SSID(s) to a WLAN Group. You can edit WLAN groups in NMS Settings → WLAN .
Guest Network Group	Assign the access point's 2.4GHz or 5GHz SSID(s) to a Guest Network Group. You can edit Guest Network groups in NMS Settings → Guest Network .
RADIUS Group	Assign the access point's 2.4GHz SSID(s) to a RADIUS group. You can edit RADIUS groups in NMS Settings → RADIUS .
Access Control Group	Assign the access point's 2.4GHz SSID(s) to a RADIUS group. You can edit RADIUS groups in NMS Settings → Access Control

Add/Edit Access Point Group

Configure your selected access point group. Access point group settings apply to all access points in the group, unless individually set to override group settings.

You can use **Profile Group Settings** to assign the access point group to WLAN, Guest Network, RADIUS and Access Control groups.

The **Group Settings** panel can be used to quickly move access points between existing groups: select an access point and use the drop down menu or search to select access point groups and use << and >> arrows to move APs between groups.

Basic Group Settings	
Name	System Default
Description	System default group for APs

Basic Group Settings	
Name	Edit the access point group name.
Description	Enter a description of the access point group for reference e.g. 2 nd Floor Office Group.

Radio Group Settings			
	Radio B/G/N (2.4 GHz)		Radio A/N (5.0 GHz)
Wireless	Enable ▾		Enable ▾
Band	11b/g/n ▾		11a/n/ac ▾
Auto Pilot	Enable ▾		Enable ▾
Auto Pilot Range	Ch 1 - 11 ▾		▾
Auto Pilot Interval	Half day ▾ <input type="checkbox"/> Change channel even if clients are connected		Half day ▾ <input type="checkbox"/> Change channel even if clients are connected
Channel Bandwidth	Auto ▾		Auto 80/40/20 MHz ▾
BSS BasicRateSet	all ▾		all ▾
⊖ Advanced Settings			
	Radio B/G/N (2.4 GHz)		Radio A/N (5.0 GHz)
Contention Slot	Short ▾		Short ▾
Preamble Type	Short ▾		Short ▾
Guard Interval	Short GI ▾		Short GI ▾
802.11n Protection	Enable ▾		Enable ▾
DTIM Period	255 (1-255)		255 (1-255)
RTS Threshold	2347 (1-2347)		2347 (1-2347)
Fragment Threshold	2346 (256-2346)		2346 (256-2346)
Multicast Rate	Auto ▾		Auto ▾
Tx Power	100% ▾		100% ▾
Beacon Interval	100 (40-1000 ms)		100 (40-1000 ms)
Station idle timeout	300 (30-65535 seconds)		300 (30-65535 seconds)

Radio Group Settings	
Wireless	Enable or disable the access point group's 2.4GHz or 5GHz wireless radio. When disabled, no SSIDs on that frequency will be active.
Band	Select the wireless standard used for the access point group. Combinations of 802.11b, 802.11g, 802.11n & 802.11ac can be selected.
Auto Pilot	Enable/disable auto channel selection. Auto channel selection will automatically set the wireless channel for the access point group's 2.4GHz or 5GHz frequency based on availability and potential interference. When disabled, select a channel manually.
Auto Pilot Range	Select a range from which the auto channel setting (above) will choose a channel.
Auto Pilot Interval	Specify a frequency for how often the auto channel setting will check/reassign the wireless channel. Check/uncheck the "Change channel even if clients are connected" box according to your preference.
Channel Bandwidth	Set the channel bandwidth or use Auto (automatically select based on interference level).
BSS BasicRateSet	Set a Basic Service Set (BSS) rate: this is a series of rates to control communication frames for wireless clients.

These settings are for experienced users only. Please do not change any of the values on this page unless you are already familiar with these functions.



Changing these settings can adversely affect the performance of your access points.

Advanced Settings	
Contention Slot	Select "Short" or "Long" – this value is used for contention windows in WMM (see IV-6-7. WMM).

Preamble Type	Set the wireless radio preamble type. The preamble type in 802.11 based wireless communication defines the length of the CRC (Cyclic Redundancy Check) block for communication between the access point and roaming wireless adapters. The default value is "Short Preamble".
Guard Interval	Set the guard interval. A shorter interval can improve performance.
802.11g Protection	Enable/disable 802.11g protection, which increases reliability but reduces bandwidth (clients will send Request to Send (RTS) to access point, and access point will broadcast Clear to Send (CTS), before a packet is sent from client.)
802.11n Protection	Enable/disable 802.11n protection, which increases reliability but reduces bandwidth (clients will send Request to Send (RTS) to access point, and access point will broadcast Clear to Send (CTS), before a packet is sent from client.)
DTIM Period	Set the DTIM (delivery traffic indication message) period value of the wireless radio. The default value is 1.
RTS Threshold	Set the RTS threshold of the wireless radio. The default value is 2347.
Fragment Threshold	Set the fragment threshold of the wireless radio. The default value is 2346.
Multicast Rate	Set the transfer rate for multicast packets or use the "Auto" setting.
Tx Power	Set the power output of the wireless radio. You may not require 100% output power. Setting a lower power output can enhance security since potentially malicious/unknown users in distant areas will not be able to access your signal.
Beacon Interval	Set the beacon interval of the wireless radio. The default value is 100.
Station idle timeout	Set the interval for keepalive messages from the access point to a wireless client to verify if the station is still alive/active.

Profile Group Settings

	Radio B/G/N (2.4 GHz)	Radio A/N (5.0 GHz)
WLAN Group	Default	Default
Guest Network Group	Disable	Disable
RADIUS Group		
Access Control Group	Default	

Group Settings

Members

Search

Group Name: System Default

MAC Address	Device Name
No Access Point.	

<<

>>

Search

AP Group 02

MAC Address	Device Name
74:DA:38:03:B6:20	AP74DA3803B620

Profile Group Settings	
WLAN Group	Assign the access point group’s 2.4GHz or 5GHz SSIDs to a WLAN Group. You can edit WLAN groups in NMS Settings → WLAN .
Guest Network Group	Assign the access point group’s 2.4GHz or 5GHz SSIDs to a Guest Network Group. You can edit Guest Network groups in NMS Settings → Guest Network .
RADIUS Group	Assign the access point group’s 2.4GHz SSIDs to a RADIUS group. You can edit RADIUS groups in NMS Settings → RADIUS .
Access Control Group	Assign the access point’s 2.4GHz SSIDs to a RADIUS group. You can edit RADIUS groups in NMS Settings → Access Control .

IV-5-2. WLAN

Displays information about each WLAN and WLAN group in the local network and allows you to add or edit WLANs & WLAN Groups. When you add a WLAN Group, it will be available for selection in **NMS Settings** → **Access Point** access point **Profile Settings** & access point group **Profile Group Settings (IV-5-1.)**

The **search** function can be used to locate a WLAN or WLAN Group. Type in the search box and the list will update:

Search Match whole words

WLAN

Search Match whole words

<input type="checkbox"/>	Name/ESSID	VLAN ID	Authentication	Encryption	Additional Authentication
<input type="checkbox"/>	matt2.4	1	WPA2-PSK	AES	No additional authentication
<input type="checkbox"/>	matt5	1	WPA2-PSK	AES	No additional authentication

WLAN Group

Search Match whole words

<input type="checkbox"/>	Group Name	WLAN members	WLAN member list
<input type="checkbox"/>	Default	0	
<input type="checkbox"/>	WLAN Group 2	1	matt2.4
<input type="checkbox"/>	WLAN Group 3	1	matt5

Select a WLAN or WLAN Group using the check-boxes and click “**Edit**” or click “**Add**” to add a new WLAN or WLAN Group:



Add/Edit WLAN

WLAN Settings	
Name/ESSID	<input type="text" value="matt2.4"/>
Description	<input type="text" value="Created by Wizard"/>
VLAN ID	<input type="text" value="1"/>
Broadcast SSID	<input type="button" value="Enable"/>
Wireless Client Isolation	<input type="button" value="Disable"/>
Load Balancing	<input type="text" value="50"/> /50
Authentication Method	<input type="button" value="WPA-PSK"/>
WPA Type	<input type="button" value="WPA2 Only"/>
Encryption Type	<input type="button" value="AES"/>
Key Renewal Interval	<input type="text" value="60"/> minute(s)
Pre-shared Key Type	<input type="button" value="Passphrase"/>
Pre-shared Key	<input type="text" value="abcd1234"/>
Additional Authentication	<input type="button" value="No additional authentication"/>

WLAN Advanced Settings	
Smart Handover Settings	
Smart Handover	<input type="radio"/> Enable <input checked="" type="radio"/> Disable
RSSI Threshold	<input type="text" value="-80"/> dB

WLAN Settings	
Name/ESSID	Edit the WLAN name (SSID).
Description	Enter a description of the SSID for reference e.g. 2 nd Floor Office HR.
SSID	Select which SSID to configure security settings for.
VLAN ID	Specify the VLAN ID.
Broadcast SSID	Enable or disable SSID broadcast. When enabled, the SSID will be visible to clients as an available Wi-Fi network. When disabled, the SSID will not be visible as an available Wi-Fi network to clients – clients must manually enter the SSID in order to connect. A hidden (disabled) SSID is typically more secure than a visible (enabled) SSID.
Wireless Client Isolation	Enable or disable wireless client isolation. Wireless client isolation prevents clients connected to the access point from communicating with each other and improves security. Typically, this function is useful for corporate environments or public hot spots and can prevent brute force attacks on

	clients' usernames and passwords.
Load Balancing	Load balancing limits the number of wireless clients connected to an SSID. Set a load balancing value (maximum 50).
Authentication Method	Select an authentication method from the drop down menu.
Additional Authentication	Select an additional authentication method from the drop down menu.

Various security options (wireless data encryption) are available. When data is encrypted, information transmitted wirelessly cannot be read by anyone who does not know the correct encryption key.



It's essential to configure wireless security in order to prevent unauthorised access to your network.



Select hard-to-guess passwords which include combinations of numbers, letters and symbols, and change your password regularly.

Please refer to **IV-6-2-3.Security** for more information on authentication and additional authentication types.

WLAN Advanced Settings	
Smart Handover	Enable or disable Smart Handover.
RSSI Threshold	Set a RSSI Threshold level.

Add/Edit WLAN Group

When you add a WLAN Group, it will be available for selection in **NMS Settings** → **Access Point** access point **Profile Settings** & access point group **Profile Group Settings (IV-5-1.)**

WLAN Group Settings			
Name	WLAN Group 2		
Description	Created by Wizard		
	Search	<input type="text"/>	<input type="checkbox"/> Match whole words
Members	<input type="checkbox"/>	Name/ESSID	VLAN ID
	<input checked="" type="checkbox"/>	matt2.4	<input type="checkbox"/> Override 1
	<input type="checkbox"/>	matt5	<input type="checkbox"/> Override 1

WLAN Group Settings	
Name	Edit the WLAN Group name.
Description	Enter a description of the WLAN Group for reference e.g. 2 nd Floor Office HR Group.
Members	Select SSIDs to include in the group using the checkboxes and assign VLAN IDs.

IV-5-3. RADIUS

Displays information about External & Internal RADIUS Servers, Accounts and Groups and allows you to add or edit RADIUS Servers, Accounts & Groups. When you add a RADIUS Group, it will be available for selection in **NMS Settings → Access Point** access point **Profile Settings** & access point group **Profile Group Settings (IV-5-1.)**

The **search** function can be used to locate a RADIUS Server, Account or Group. Type in the search box and the list will update:

Search Match whole words

Make a selection using the check-boxes and click “**Edit**” or click “**Add**” to add a new WLAN or WLAN Group:



External RADIUS Server

Search Match whole words

<input type="checkbox"/>	Name	RADIUS server	Authentication Port	Session Timeout (sec)	Accounting
Please add External RADIUS Server setting					

Internal RADIUS Server

Search Match whole words

<input type="checkbox"/>	Name	EAP Authentication	Session Timeout (sec)	Termination-Action
Please add Internal RADIUS Server setting				

RADIUS Account

Search Match whole words

<input type="checkbox"/>	Name	Password
Please add User Account		

RADIUS Group

Search Match whole words

<input type="checkbox"/>	Name	2.4GHz	5GHz	RADIUS accounts
Please add RADIUS group setting				

Add/Edit External RADIUS Server

External RADIUS Server	
Name	<input type="text"/>
Description	<input type="text"/>
RADIUS Server	<input type="text"/>
Authentication Port	<input type="text" value="1812"/>
Shared Secret	<input type="text"/>
Session Timeout	<input type="text" value="3600"/> Seconds
Accounting	<input checked="" type="radio"/> Enable <input type="radio"/> Disable
Accounting Port	<input type="text" value="1813"/>

Name	Enter a name for the RADIUS Server.
Description	Enter a description of the RADIUS Server for reference.
RADIUS Server	Enter the RADIUS server host IP address.
Authentication Port	Set the UDP port used in the authentication protocol of the RADIUS server. Value must be between 1 – 65535.
Shared Secret	Enter a shared secret/password between 1 – 99 characters in length. This should match the “MAC-RADIUS” password used in IV-3-1-3-6 or IV-3-2-3 .
Session Timeout	Set a duration of session timeout in seconds between 0 – 86400.
Accounting	Enable or disable RADIUS accounting.
Accounting Port	When accounting is enabled (above), set the UDP port used in the accounting protocol of the RADIUS server. Value must be between 1 – 65535.

Upload EAP Certificate File	
EAP Certificate File Format	PKCS#12(*.pfx/* .p12)
Upload EAP Certificate File	<input type="button" value="Choose File"/> No file chosen
Password of EAP Certificate File	<input type="text"/>
<input type="button" value="Upload"/>	

Internal RADIUS Server	
Name	<input type="text"/>
Description	<input type="text"/>
EAP Internal Authentication	PEAP(MS-PEAP) ▾
Shared Secret	<input type="text"/>
Session-Timeout	3600 <input type="text"/> Seconds
Termination-Action	<input checked="" type="radio"/> Reauthentication (RADIUS-Request) <input type="radio"/> Not-Reauthentication (Default) <input type="radio"/> Not-Send

Add/Edit Internal RADIUS Server

Upload EAP Certificate File	
EAP Certificate File Format	Displays the EAP certificate file format: PCK#12(*.pfx/* .p12)
EAP Certificate File	Click "Upload" to open a new window and select the location of an EAP certificate file to use. If no certificate file is uploaded, the internal RADIUS server will use a self-made certificate.

Internal RADIUS Server	
Name	Enter a name for the Internal RADIUS Server.
Description	Enter a description of the Internal RADIUS Server for reference.
EAP Certificate File Format	Displays the EAP certificate file format: PCK#12(*.pfx/* .p12)
EAP Certificate File	Click "Upload" to open a new window and select the location of an EAP certificate file to use. If no certificate file is uploaded, the internal RADIUS server will use a self-made certificate.
EAP Internal Authentication	Select EAP internal authentication type from the drop down menu.

Shared Secret	Enter a shared secret/password for use between the internal RADIUS server and RADIUS client. The shared secret should be 1 – 99 characters in length.
Session Timeout	Set a duration of session timeout in seconds between 0 – 86400.
Termination Action	Select a termination-action attribute: “Reauthentication” sends a RADIUS request to the access point, “Not-Reathentication” sends a default termination-action attribute to the access point, “Not-Send” no termination-action attribute is sent to the access point.

Add/Edit RADIUS Accounts

The internal RADIUS server can authenticate up to 256 user accounts. The “RADIUS Accounts” page allows you to configure and manage users.

RADIUS Accounts

User Name
Example: USER1, USER2, USER3, USER4

Enter username here

Add Reset

User Registration List

Select	User Name	Password	Customize
<input type="checkbox"/>	Edimax	Not Configured	Edit

Delete Selected Delete All



Edit User Registration List

User Name Edimax (4-16characters)

Password (6-32characters)

RADIUS Accounts	
User Name	Enter the user names here, separated by commas.
Add	Click "Add" to add the user to the user registration list.
Reset	Clear text from the user name box.

User Registration List	
Select	Check the box to select a user.
User Name	Displays the user name.
Password	Displays if specified user name has a password (configured) or not (not configured).
Customize	Click "Edit" to open a new field to set/edit a password for the specified user name (below).

Delete Selected	Delete selected user from the user registration list.
Delete All	Delete all users from the user registration list.

Edit User Registration List	
User Name	Existing user name is displayed here and can be edited according to your preference.
Password	Enter or edit a password for the specified user.

Add/Edit RADIUS Group

When you add a RADIUS Group, it will be available for selection in **NMS Settings → Access Point** access point **Profile Settings** & access point group **Profile Group Settings (IV-5-1.)**

RADIUS Group Settings							
Group Name	<input type="text"/>						
Description	<input type="text"/>						
2.4GHz RADIUS	Primary : <input type="text" value="Disabled"/> Secondary : <input type="text" value="Disabled"/>						
5GHz RADIUS	Primary : <input type="text" value="Disabled"/> Secondary : <input type="text" value="Disabled"/>						
Members	Search <input type="text"/> <input type="checkbox"/> Match whole words <table border="1"> <thead> <tr> <th><input type="checkbox"/></th> <th>Username</th> <th>Password</th> </tr> </thead> <tbody> <tr> <td><input type="button" value="Add"/></td> <td><input type="text"/></td> <td><input type="text"/></td> </tr> </tbody> </table>	<input type="checkbox"/>	Username	Password	<input type="button" value="Add"/>	<input type="text"/>	<input type="text"/>
<input type="checkbox"/>	Username	Password					
<input type="button" value="Add"/>	<input type="text"/>	<input type="text"/>					

RADIUS Group Settings	
Group Name	Edit the RADIUS Group name.
Description	Enter a description of the RADIUS Group for reference.
2.4GHz RADIUS	Enable/Disable primary & secondary RADIUS servers for 2.4GHz.
5GHz RADIUS	Enable/Disable primary & secondary RADIUS servers for 5GHz.
Members	Add RADIUS user accounts to the RADIUS group.

IV-5-4. Access Control

MAC Access Control is a security feature that can help to prevent unauthorized users from connecting to your access point.

This function allows you to define a list of network devices permitted to connect to the access point. Devices are each identified by their unique MAC address. If a device which is not on the list of permitted MAC addresses attempts to connect to the access point, it will be denied.

The Access Control panel displays information about MAC Access Control & MAC Access Control Groups and Groups and allows you to add or edit MAC Access Control & MAC Access Control Group settings. When you add an Access Control Group, it will be available for selection in **NMS Settings → Access Point** access point **Profile Settings** & access point group **Profile Group Settings (IV-5-1.)**

The **search** function can be used to locate a MAC address or MAC Access Control Group. Type in the search box and the list will update:



Make a selection using the check-boxes and click “**Edit**” or click “**Add**” to add a new MAC Address or MAC Access Control Group:



MAC Access Control

Search Match whole words

<input type="checkbox"/>	MAC Address	Description
Please add MAC Access Control setting		

MAC Access Control Group

Search Match whole words

<input type="checkbox"/>	Group Name	Policy	Members
<input type="checkbox"/>	Default	Blacklist	0

Add/Edit MAC Access Control

MAC Access Control

Add MAC Address

Remain entries (256)

MAC Access Control List

MAC Address	Description	Delete
Please add MAC Addresses		

Add MAC Address	Enter a MAC address of computer or network device manually e.g. 'aa-bb-cc-dd-ee-ff' or enter multiple MAC addresses separated with commas, e.g. 'aa-bb-cc-dd-ee-ff,aa-bb-cc-dd-ee-gg'
Add	Click "Add" to add the MAC address to the MAC address filtering table.
Reset	Clear all fields.

MAC address entries will be listed in the "MAC Address Filtering Table". Select an entry using the "Select" checkbox.

Select	Delete selected or all entries from the table.
MAC Address	The MAC address is listed here.
Delete Selected	Delete the selected MAC address from the list.
Delete All	Delete all entries from the MAC address filtering table.
Export	Click "Export" to save a copy of the MAC filtering table. A new window will pop up for you to select a location to save the file.

Add/Edit MAC Access Control Group

When you add an Access Control Group, it will be available for selection in **NMS Settings → Access Point** access point **Profile Settings** & access point group **Profile Group Settings (IV-5-1.)**

MAC Filter Group Settings							
Group Name	<input type="text" value="Please enter a new group name"/>						
Description	<input type="text" value="Please enter a new group description"/>						
Action	Blacklist ▾						
	Search <input type="text"/> <input type="checkbox"/> Match whole words						
Members	<table border="1"> <thead> <tr> <th><input type="checkbox"/></th> <th>MAC Address</th> <th>Description</th> </tr> </thead> <tbody> <tr> <td colspan="3" style="text-align: center;">No MAC Access Control Profile</td> </tr> </tbody> </table>	<input type="checkbox"/>	MAC Address	Description	No MAC Access Control Profile		
<input type="checkbox"/>	MAC Address	Description					
No MAC Access Control Profile							

MAC Filter Group Settings	
Group Name	Edit the MAC Access Control Group name.
Description	Enter a description of the MAC Access Control Group for reference.
Action	Select “Blacklist” to deny access to specified MAC addresses in the group, and select “Whitelist” to permit access to specified MAC address in the group.
Members	Add MAC addresses to the group.

IV-5-5. Guest Network

You can setup an additional “Guest” Wi-Fi network so guest users can enjoy Wi-Fi connectivity without accessing your primary networks. The “Guest” screen displays settings for your guest Wi-Fi network.

The Guest Network panel displays information about Guest Networks and Guest Network Groups and allows you to add or edit Guest Network and Guest Network Group settings. When you add a Guest Network Group, it will be available for selection in **NMS Settings → Access Point access point Profile Settings & access point group Profile Group Settings (IV-5-1.)**

The **search** function can be used to locate a Guest Network or Guest Network Group. Type in the search box and the list will update:

Search Match whole words

Make a selection using the check-boxes and click “**Edit**” or click “**Add**” to add a new Guest Network or Guest Network Group.



Guest Network

Search Match whole words

<input type="checkbox"/>	Name/ESSID	VLAN ID	Authentication	Encryption	Additional Authentication
Please add Guest Network setting					

Guest Network Group

Search Match whole words

<input type="checkbox"/>	Group Name	Guest Network members	Guest Network member list
Please add Guest Network Group setting			

Add/Edit Guest Network

Guest Network Settings	
Name/ESSID	<input type="text"/>
Description	<input type="text"/>
VLAN ID	<input type="text" value="1"/>
Broadcast SSID	Enable ▾
Wireless Client Isolation	STA Separator ▾
Load Balancing	<input type="text" value="50"/> /50
WMM	Enable ▾
Authentication Method	No Authentication ▾
Additional Authentication	No additional authentication ▾

Guest Access Policy													
Traffic Shaping Settings													
Traffic Shaping	Disable ▾												
Downlink	<input type="text" value="50"/> MB												
Uplink	<input type="text" value="50"/> MB												
Filtering Settings													
IP Filtering	Disable ▾												
Rules	<table border="1"> <thead> <tr> <th><input type="checkbox"/></th> <th colspan="2">IP/Subnet Mask</th> </tr> </thead> <tbody> <tr> <td><input type="checkbox"/></td> <td>0.0.0.0</td> <td>/0.0.0.0</td> </tr> <tr> <td><input type="checkbox"/></td> <td>0.0.0.0</td> <td>/0.0.0.0</td> </tr> <tr> <td><input type="checkbox"/></td> <td>0.0.0.0</td> <td>/0.0.0.0</td> </tr> </tbody> </table>	<input type="checkbox"/>	IP/Subnet Mask		<input type="checkbox"/>	0.0.0.0	/0.0.0.0	<input type="checkbox"/>	0.0.0.0	/0.0.0.0	<input type="checkbox"/>	0.0.0.0	/0.0.0.0
<input type="checkbox"/>	IP/Subnet Mask												
<input type="checkbox"/>	0.0.0.0	/0.0.0.0											
<input type="checkbox"/>	0.0.0.0	/0.0.0.0											
<input type="checkbox"/>	0.0.0.0	/0.0.0.0											

Guest Network Settings	
Name/ESSID	Edit the Guest Network name (SSID).
Description	Enter a description of the Guest Network for reference e.g. 2 nd Floor Office HR.
VLAN ID	Specify the VLAN ID.
Broadcast SSID	Enable or disable SSID broadcast. When enabled, the SSID will be visible to clients as an available Wi-Fi network. When disabled, the SSID will not be visible as an available Wi-Fi network to clients – clients must manually enter the SSID in order to connect. A hidden (disabled) SSID is typically more secure than a visible (enabled) SSID.
Wireless Client Isolation	Enable or disable wireless client isolation. Wireless client isolation prevents clients connected to the access point from communicating with each other and improves security. Typically, this function is useful for corporate environments or public hot spots and can prevent brute force attacks on

	clients' usernames and passwords.
Load Balancing	Load balancing limits the number of wireless clients connected to an SSID. Set a load balancing value (maximum 50).
WMM	Enable or disable WMM (Wi-Fi Multimedia) traffic prioritizing.
Authentication Method	Select an authentication method from the drop down menu.
Additional Authentication	Select an additional authentication method from the drop down menu.

Various security options (wireless data encryption) are available. When data is encrypted, information transmitted wirelessly cannot be read by anyone who does not know the correct encryption key.



It's essential to configure wireless security in order to prevent unauthorised access to your network.



Select hard-to-guess passwords which include combinations of numbers, letters and symbols, and change your password regularly.

Please refer to **IV-6-2-3.Security** for more information on authentication and additional authentication types.

Guest Access Policy	
Traffic Shaping	Enable or disable traffic shaping for the guest network.
Downlink	Enter a downlink limit in MB.
Uplink	Enter an uplink limit in MB.
IP Filtering	Select "Deny" or "Allow" to deny or allow specified IP addresses to access the guest network. Select "Disable" to disable IP filtering.
Rules	Enter IP addresses to be filtered according to the Deny or Allow rule specified above and check the box for each IP address to be filtered.

Add/Edit Guest Network Group

When you add a Guest Network Group, it will be available for selection in **NMS Settings → Access Point** access point **Profile Settings** & access point group **Profile Group Settings (IV-5-1.)**

Guest Group Settings					
Name	<input type="text"/>				
Description	<input type="text"/>				
Members	Search <input type="text"/> <input type="checkbox"/> Match whole words <input type="checkbox"/> <table border="1"> <thead> <tr> <th>Name/ESSID</th> <th>VLAN ID</th> </tr> </thead> <tbody> <tr> <td> </td> <td> </td> </tr> </tbody> </table>	Name/ESSID	VLAN ID		
Name/ESSID	VLAN ID				

Guest Network Group Settings	
Group Name	Edit the Guest Network Group name.
Description	Enter a description of the Guest Network for reference.
Members	Add SSIDs to the Guest Network group.

IV-5-6. Zone Edit

Zone Edit displays information about zones for use with the Zone Plan feature and allows you to add or edit zones.

The **search** function can be used to find existing zones. Type in the search box and the list will update:



Make a selection using the check-boxes and click **“Edit”** or click **“Add”** to add a new zone.

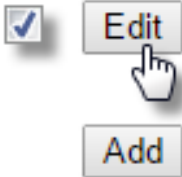

Zone Edit

Search Match whole words

<input type="checkbox"/>	Name/Location	Map	Map Size	Number of APs
<input type="checkbox"/>	EDIMAX_SF		230371 bytes	2

Add/Edit Zone

Upload Zone Image

Map Image File No file chosen

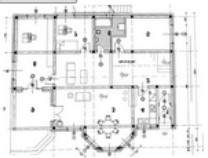

Zone Setting

Name/Location

Description

Member(s)

Search Match whole words

	MAC Address	Device Name	Model	Status
<input type="checkbox"/>	System Default			
<input checked="" type="checkbox"/>	74:DA:38:03:B5:30	AP74DA3803B530	WAP1750	<input type="radio"/>
<input checked="" type="checkbox"/>	74:DA:38:00:00:B4	AP74DA380000B4		<input type="radio"/>
<input checked="" type="checkbox"/>	80:1F:02:75:EA:38			<input type="radio"/>

Upload Zone Image	
Choose File	Click to locate an image file to be displayed as a map in the Zone Plan feature. Typically a floor plan image is useful.
Zone Setting	
Name/Location	Enter a name of the zone/location.
Description	Enter a description of the zone/location for reference.
Members	Assign access points to the specified zone/location for use with the Zone Plan feature.

IV-5-7. Firmware Upgrade

Firmware Upgrade allows you to upgrade firmware to Access Point Groups. First, upload the firmware file from a local disk or external FTP server: locate the file and click “Upload” or “Check”. The table below will display the *Firmware Name*, *Firmware Version*, *NMS Version*, *Model* and *Size*.

Then click “Upgrade All” to upgrade all access points in the Array or select Access Point groups from the list using check-boxes and click “Upgrade Selected” to upgrade only selected access points.

Firmware Upgrade

Local External FTP Server

Firmware Update File	<input style="width: 95%;" type="text"/>
FTP Server Address	<input style="width: 95%;" type="text"/>
Username	<input style="width: 95%;" type="text"/>
Password	<input style="width: 95%;" type="password"/> <input type="checkbox"/> Show password

Firmware Name	Firmware Version	NMS Version	Model	Size (bytes)

Access Point Groups

Group Name	MAC Address	Device Name	Model	IP Address	Status	Firmware Version	NMS Version	Progress
System Default (0)								
No Access Point in this group.								
AP Group 02 (1)								
<input type="checkbox"/>	74:DA:38:03:B6:20	AP74DA3803B620	WAP1750	192.168.8.21	●	0.9.8	0.9.8.1	0%

IV-5-8. Advanced

IV-5-8-1. System Security

Configure the NMS system login name and password.

System Security	
NMS System Name	<input type="text" value="administrator"/>
NMS Security Key	<input type="text" value="1234567890123456"/> (8~16 Characters)
<input type="button" value="Apply"/>	

IV-5-8-2. Date & Time

Configure the date & time settings of the AP Array. The date and time of the access points can be configured manually or can be synchronized with a time server.

Date and Time Settings	
Local Time	2012 ▼ Year Jan ▼ Month 1 ▼ Day 0 ▼ Hours 00 ▼ Minutes 00 ▼ Seconds
<input type="button" value="Acquire Current Time from Your PC"/>	
NTP Time Server	
Use NTP	<input type="checkbox"/> Enable
Server Name	<input type="text"/>
Update Interval	24 (Hours)
Time Zone	
Time Zone	(GMT-06:00) Central Time (US & Canada) ▼

Date and Time Settings	
Local Time	Set the access point's date and time manually using the drop down menus.
Acquire Current Time from your PC	Click "Acquire Current Time from Your PC" to enter the required values automatically according to your computer's current time and date.

NTP Time Server	
Use NTP	The access point also supports NTP (Network Time Protocol) for automatic time and date setup.
Server Name	Enter the host name or IP address of the time server if you wish.
Update Interval	Specify a frequency (in hours) for the access point to update/synchronize with the NTP server.

Time Zone	
Time Zone	Select the time zone of your country/ region. If your country/region is not listed, please select another country/region whose time zone is the same as yours.

IV-6. Local Network

IV-6-1. Network Settings

IV-6-1-1. LAN-Side IP Address

The “LAN-side IP address” page allows you to configure your AP Controller on your Local Area Network (LAN). You can enable the access point to dynamically receive an IP address from your router’s DHCP server or you can specify a static IP address for your access point, as well as configure DNS servers. You can also set your AP Controller as a DHCP server to assign IP addresses to other devices on your LAN.



The access point’s default IP address is 192.168.2.2



Disable other DHCP servers on the LAN if using AP Controllers DHCP Server.

LAN-side IP Address	
IP Address Assignment	Static IP Address ▾
IP Address	192.168.222.220
Subnet Mask	255.255.255.0
Default Gateway	192.168.222.1
Primary DNS Address	0.0.0.0
Secondary DNS Address	0.0.0.0

LAN-side IP Address	
IP Address Assignment	Select “Static IP” to manually specify a static/fixed IP address for your access point. Select “DHCP Client” for your access point to be assigned a dynamic IP address from your router’s DHCP server, or select “DHCP Server” for your access point to act as a DHCP server and assign IP addresses on your LAN.

Static IP Address	
IP Address	Specify the IP address here. This IP address will be assigned to your access point and will

	replace the default IP address.
Subnet Mask	Specify a subnet mask. The default value is 255.255.255.0
Default Gateway	For DHCP users, select “From DHCP” to get default gateway from your DHCP server or “User-Defined” to enter a gateway manually. For static IP users, the default value is blank.
Primary DNS Address	For static IP users, the default value is blank.
Secondary DNS Address	For static IP users, the default value is blank.

LAN-side IP Address	
IP Address Assignment	DHCP Client ▼
IP Address	192.168.222.220
Subnet Mask	255.255.255.0
Default Gateway	From DHCP ▼ 192.168.222.1
Primary DNS Address	From DHCP ▼ 0.0.0.0
Secondary DNS Address	From DHCP ▼ 0.0.0.0

DHCP Client	
IP Address	When “DHCP Client” is selected this value cannot be modified.
Subnet Mask	When “DHCP Client” is selected this value cannot be modified.
Default Gateway	Select “From DHCP” or select “User-Defined” and enter a default gateway.
Primary DNS Address	Select “From DHCP” or select “User-Defined” and enter a primary DNS address.
Secondary DNS Address	Select “From DHCP” or select “User-Defined” and enter a secondary DNS address.

LAN-side IP Address	
IP Address Assignment	DHCP Server ▾
IP Address	192.168.222.220
Subnet Mask	255.255.255.0
IP Address Range	192.168.222.120 ~ 192.168.222.140
Domain Name	WAP1750
Lease Time	Forever ▾
Default Gateway	192.168.222.1
Primary DNS Address	0.0.0.0
Secondary DNS Address	0.0.0.0

DHCP Server Static IP Address			
Index	MAC Address	IP Address	Action
1	<input type="text"/>	<input type="text"/>	<input type="button" value="Add"/>

DHCP Client List			
Index	MAC Address	IP Address	Lease Time
No DHCP Client			

DHCP Server	
IP Address	Specify the IP address here. This IP address will be assigned to your access point and will replace the default IP address.
Subnet Mask	Specify a subnet mask. The default value is 255.255.255.0
IP Address Range	Enter the start and end IP address of the IP address range which your access point's DHCP server will assign to devices on the network.
Domain Name	Enter a domain name.
Lease Time	Select a lease time from the drop down menu. IP addresses will be assigned for this period of time.
Default Gateway	Enter a default gateway.
Primary DNS Address	Enter a primary DNS address.
Secondary DNS Address	Enter a secondary DNS address.

Your access point's DHCP server can be configured to assign static (fixed) IP addresses to specified network devices, identified by their unique MAC address:

DHCP Server Static IP Address	
MAC Address	Enter the MAC address of the network device to be assigned a static IP address.

IP Address	Specify the IP address to assign the device.
Add	Click to assign the IP address to the device.

IV-6-1-2. LAN Port Settings

The “LAN Port” page allows you to configure the settings for your AP Controllers wired LAN (Ethernet) ports.

Wired LAN Port Settings				
Wired LAN Port	Enable	Speed & Duplex	Flow Control	802.3az
Wired Port (#1)	Enabled ▾	Auto ▾	Enabled ▾	Enabled ▾
Wired Port (#2)	Enabled ▾	Auto ▾	Enabled ▾	Enabled ▾

Wired LAN Port	Identifies LAN port 1 or 2.
Enable	Enable/disable specified LAN port.
Speed & Duplex	Select a speed & duplex type for specified LAN port, or use the “Auto” value. LAN ports can operate up to 1000Mbps and full-duplex enables simultaneous data packets transfer/receive.
Flow Control	Enable/disable flow control. Flow control can pause new session request until current data processing is complete, in order to avoid device overloads under heavy traffic.
802.3az	Enable/disable 802.3az. 802.3az is an Energy Efficient Ethernet feature which disables unused interfaces to reduce power usage.

IV-6-1-3. VLAN

The “VLAN” (Virtual Local Area Network) page enables you to configure VLAN settings. A VLAN is a local area network which maps workstations virtually instead of physically and allows you to group together or isolate users from each other. VLAN IDs 1 – 4095 are supported.



VLAN IDs in the range 1 – 4095 are supported.

VLAN Interface		
Wired LAN Port	VLAN Mode	VLAN ID
Wired Port (#1)	Untagged Port ▼	1
Wired Port (#2)	Untagged Port ▼	1
Wireless 2.4GHz	VLAN Mode	VLAN ID
SSID [AMPED_DNS_TEST]	Untagged Port	1

Management VLAN	
VLAN ID	1

VLAN Interface	
Wired LAN Port/Wireless	Identifies LAN port 1 or 2 and wireless SSIDs (2.4GHz or 5GHz).
VLAN Mode	Select “Tagged Port” or “Untagged Port” for specified LAN interface.
VLAN ID	Set a VLAN ID for specified interface, if “Untagged Port” is selected.

Management VLAN	
VLAN ID	Specify the VLAN ID of the management VLAN. Only the hosts belonging to the same VLAN can manage the device.

IV-6-2. 2.4GHz 11bgn

The “2.4GHz 11bgn” menu allows you to view and configure information for your access point’s 2.4GHz wireless network across four categories: Basic, Advanced, Security and WDS.

IV-6-2-1. Basic

The “Basic” screen displays basic settings for your access point’s 2.4GHz Wi-Fi network(s).

2.4GHz Basic Settings	
Wireless	<input checked="" type="radio"/> Enable <input type="radio"/> Disable
Band	11b/g/n ▼
Enable SSID number	1 ▼
SSID1	AMPED_DNS_TEST <input type="text"/> VLAN ID <input type="text" value="1"/>
Auto Channel	<input checked="" type="radio"/> Enable <input type="radio"/> Disable
Auto Channel Range	Ch 1 - 11 ▼
Auto Channel Interval	One day ▼ <input type="checkbox"/> Change channel even if clients are connected
Channel Bandwidth	Auto ▼
BSS BasicRateSet	1,2,5,5,11 Mbps ▼



Auto Channel	<input type="radio"/> Enable <input checked="" type="radio"/> Disable
Channel	Ch 11, 2462MHz ▼
Channel Bandwidth	Auto, +Ch 7 ▼
BSS BasicRateSet	1,2,5,5,11 Mbps ▼

Wireless	Enable or disable the access point’s 2.4GHz wireless radio. When disabled, no 2.4GHz SSIDs will be active.
Band	Select the wireless standard used for the access point. Combinations of 802.11b, 802.11g & 802.11n can be selected.
Enable SSID Number	Select how many SSIDs to enable for the 2.4GHz frequency from the drop down menu. A maximum of 16 can be enabled.
SSID#	Enter the SSID name for the specified SSID (up

	to 16). The SSID can consist of any combination of up to 32 alphanumeric characters.
VLAN ID	Specify a VLAN ID for each SSID.
Auto Channel	Enable/disable auto channel selection. Auto channel selection will automatically set the wireless channel for the access point's 2.4GHz frequency based on availability and potential interference. When disabled, select a channel manually as shown in the next table.
Auto Channel Range	Select a range from which the auto channel setting (above) will choose a channel.
Auto Channel Interval	Specify a frequency for how often the auto channel setting will check/reassign the wireless channel. Check/uncheck the "Change channel even if clients are connected" box according to your preference.
Channel Bandwidth	Set the channel bandwidth: 20MHz (lower performance but less interference), 40MHz (higher performance but potentially higher interference) or Auto (automatically select based on interference level).
BSS BasicRateSet	Set a Basic Service Set (BSS) rate: this is a series of rates to control communication frames for wireless clients.

When auto channel is disabled, select a wireless channel manually:

Channel	Select a wireless channel from 1 – 11.
Channel Bandwidth	Set the channel bandwidth: 20MHz (lower performance but less interference), 40MHz (higher performance but potentially higher interference) or Auto (automatically select based on interference level).
BSS BasicRate Set	Set a Basic Service Set (BSS) rate: this is a series of rates to control communication frames for wireless clients.

IV-6-2-2. Advanced

These settings are for experienced users only. Please do not change any of the values on this page unless you are already familiar with these functions.



Changing these settings can adversely affect the performance of your access point.

2.4GHz Advanced Settings	
Contention Slot	Short ▾
Preamble Type	Short ▾
Guard Interval	Short GI ▾
802.11g Protection	<input checked="" type="radio"/> Enable <input type="radio"/> Disable
802.11n Protection	<input checked="" type="radio"/> Enable <input type="radio"/> Disable
DTIM Period	1 (1-255)
RTS Threshold	2347 (1-2347)
Fragment Threshold	2346 (256-2346)
Multicast Rate	Auto ▾
Tx Power	100% ▾
Beacon Interval	100 (40-1000 ms)
Station idle timeout	60 (30-65535 seconds)

Contention Slot	Select “Short” or “Long” – this value is used for contention windows in WMM (see IV-6-7. WMM).
Preamble Type	Set the wireless radio preamble type. The preamble type in 802.11 based wireless communication defines the length of the CRC (Cyclic Redundancy Check) block for communication between the access point and roaming wireless adapters. The default value is “Short Preamble”.
Guard Interval	Set the guard interval. A shorter interval can improve performance.
802.11g Protection	Enable/disable 802.11g protection, which increases reliability but reduces bandwidth (clients will send Request to Send (RTS) to access point, and access point will broadcast Clear to Send (CTS), before a packet is sent from client.)

802.11n Protection	Enable/disable 802.11n protection, which increases reliability but reduces bandwidth (clients will send Request to Send (RTS) to access point, and access point will broadcast Clear to Send (CTS), before a packet is sent from client.)
DTIM Period	Set the DTIM (delivery traffic indication message) period value of the wireless radio. The default value is 1.
RTS Threshold	Set the RTS threshold of the wireless radio. The default value is 2347.
Fragment Threshold	Set the fragment threshold of the wireless radio. The default value is 2346.
Multicast Rate	Set the transfer rate for multicast packets or use the "Auto" setting.
Tx Power	Set the power output of the wireless radio. You may not require 100% output power. Setting a lower power output can enhance security since potentially malicious/unknown users in distant areas will not be able to access your signal.
Beacon Interval	Set the beacon interval of the wireless radio. The default value is 100.
Station idle timeout	Set the interval for keepalive messages from the access point to a wireless client to verify if the station is still alive/active.

IV-6-2-3. Security

The access point provides various security options (wireless data encryption). When data is encrypted, information transmitted wirelessly cannot be read by anyone who does not know the correct encryption key.



It's essential to configure wireless security in order to prevent unauthorised access to your network.



Select hard-to-guess passwords which include combinations of numbers, letters and symbols, and change your password regularly.

2.4GHz Wireless Security Settings	
SSID	AMPED_DNS_TEST ▾
Broadcast SSID	Enable ▾
Wireless Client Isolation	Disable ▾
Load Balancing	50 /50
Authentication Method	No Authentication ▾
Additional Authentication	No additional authentication ▾

SSID	Select which SSID to configure security settings for.
Broadcast SSID	Enable or disable SSID broadcast. When enabled, the SSID will be visible to clients as an available Wi-Fi network. When disabled, the SSID will not be visible as an available Wi-Fi network to clients – clients must manually enter the SSID in order to connect. A hidden (disabled) SSID is typically more secure than a visible (enabled) SSID.
Wireless Client Isolation	Enable or disable wireless client isolation. Wireless client isolation prevents clients connected to the access point from communicating with each other and improves security. Typically, this function is useful for corporate environments or public hot spots and can prevent brute force attacks on clients' usernames and passwords.

Load Balancing	Load balancing limits the number of wireless clients connected to an SSID. Set a load balancing value (maximum 50).
Authentication Method	Select an authentication method from the drop down menu and refer to the information below appropriate for your method.
Additional Authentication	Select an additional authentication method from the drop down menu and refer to the information below (IV-6-2-3-6.) appropriate for your method.

IV-6-2-3-1. No Authentication

Authentication is disabled and no password/key is required to connect to the access point.



Disabling wireless authentication is not recommended. When disabled, anybody within range can connect to your device's SSID.

IV-6-2-3-2. WEP

WEP (Wired Equivalent Privacy) is a basic encryption type. For a higher level of security consider using WPA encryption.

Key Length	Select 64-bit or 128-bit. 128-bit is more secure than 64-bit and is recommended.
Key Type	Choose from "ASCII" (any alphanumerical character 0-9, a-z and A-Z) or "Hex" (any characters from 0-9, a-f and A-F).
Default Key	Select which encryption key (1 – 4 below) is the default key. For security purposes, you can set up to four keys (below) and change which is the default key.
Encryption Key 1 – 4	Enter your encryption key/password according to the format you selected above.

IV-6-2-3-3. IEEE802.1x/EAP

Key Length	Select 64-bit or 128-bit. 128-bit is more secure than 64-bit and is recommended.
-------------------	--

IV-6-2-3-4. WPA-PSK

WPA-PSK is a secure wireless encryption type with strong data protection and user authentication, utilizing 128-bit encryption keys.

WPA Type	Select from WPA/WPA2 Mixed Mode-PSK, WPA2 or WPA only. WPA2 is safer than WPA only, but not supported by all wireless clients. Please make sure your wireless client supports your selection.
Encryption	Select “TKIP/AES Mixed Mode” or “AES” encryption type.
Key Renewal Interval	Specify a frequency for key renewal in minutes.
Pre-Shared Key Type	Choose from “Passphrase” (8 – 63 alphanumeric characters) or “Hex” (up to 64 characters from 0-9, a-f and A-F).
Pre-Shared Key	Please enter a security key/password according to the format you selected above.

IV-6-2-3-5. WPA-EAP

WPA Type	Select from WPA/WPA2 Mixed Mode-EAP, WPA2-EAP or WPA-EAP.
Encryption	Select “TKIP/AES Mixed Mode” or “AES” encryption type.
Key Renewal Interval	Specify a frequency for key renewal in minutes.



WPA-EAP must be disabled to use MAC-RADIUS authentication.

IV-6-2-3-6. Additional Authentication

Additional wireless authentication methods can also be used:

MAC Address Filter

Restrict wireless clients access based on MAC address specified in the MAC filter table.



See IV-6-6. MAC Filter to configure MAC filtering.

MAC Filter & MAC-RADIUS Authentication

Restrict wireless clients access using both of the above MAC filtering & RADIUS authentication methods.

MAC-RADIUS Authentication

Restrict wireless clients access based on MAC address via a RADIUS server, or password authentication via a RADIUS server.



See IV-6-5. RADIUS to configure RADIUS servers.



WPS must be disabled to use MAC-RADIUS authentication. See IV-6-4. for WPS settings.

MAC RADIUS Password

Use MAC address
 Use the following password

MAC RADIUS Password	Select whether to use MAC address or password authentication via RADIUS server. If you select “Use the following password”, enter the password in the field below. The password should match the “Shared Secret” used in IV-6-5. RADIUS.
----------------------------	---

IV-6-2-4. WDS

Wireless Distribution System (WDS) can bridge/repeat access points together in an extended network. WDS settings can be configured as shown below.



When using WDS, configure the IP address of each access point to be in the same subnet and ensure there is only one active DHCP server among connected access points, preferably on the WAN side.

WDS must be configured on each access point, using correct MAC addresses. All access points should use the same wireless channel and encryption method.

2.4GHz	
WDS Functionality	Disabled
Local MAC Address	Disabled WDS with AP Dedicated WDS

WDS Peer Settings	
WDS #1	MAC Address
WDS #2	MAC Address
WDS #3	MAC Address
WDS #4	MAC Address

WDS VLAN	
VLAN Mode	Untagged Port (Enter at least one MAC address.)
VLAN ID	1

WDS Encryption method	
Encryption	None (Enter at least one MAC address.)

2.4GHz	
WDS Functionality	Select “WDS with AP” to use WDS with access point or “WDS Dedicated Mode” to use WDS and also block communication with regular wireless clients. When WDS is used, each access point should be configured with corresponding MAC addresses, wireless channel and wireless encryption method.
Local MAC Address	Displays the MAC address of your access point.

WDS Peer Settings	
WDS #	Enter the MAC address for up to four other WDS devices you wish to connect.

WDS VLAN	
VLAN Mode	Specify the WDS VLAN mode to “Untagged Port” or “Tagged Port”.
VLAN ID	Specify the WDS VLAN ID when “Untagged Port” is selected above.

WDS Encryption method	
Encryption	Select whether to use “None” or “AES” encryption and enter a pre-shared key for AES consisting of 8-63 alphanumeric characters.

IV-6-3. 5GHz 11ac 11an

The “5GHz 11ac 11an” menu allows you to view and configure information for your access point’s 5GHz wireless network across four categories: Basic, Advanced, Security and WDS.

IV-6-3-1. Basic

The “Basic” screen displays basic settings for your access point’s 5GHz Wi-Fi network (s).

5GHz Basic Settings	
Wireless	<input type="radio"/> Enable <input checked="" type="radio"/> Disable
Band	11a/n/ac ▼
Enable SSID number	1 ▼
SSID1	WAP1750-03EC1A_A VLAN ID 1
Auto Channel	<input checked="" type="radio"/> Enable <input type="radio"/> Disable
Auto Channel Range	Band 1 ▼
Auto Channel Interval	One day ▼
	<input type="checkbox"/> Change channel even if clients are connected
Channel Bandwidth	Auto 80/40/20 MHz ▼
BSS BasicRateSet	6,12,24 Mbps ▼



Auto Channel	<input type="radio"/> Enable <input checked="" type="radio"/> Disable
Channel	Ch 36, 5.18GHz ▼
Channel Bandwidth	Auto 80/40/20 MHz ▼
BSS BasicRateSet	6,12,24 Mbps ▼

Wireless	Enable or disable the access point’s 5GHz wireless radio. When disabled, no 5GHz SSIDs will be active.
Band	Select the wireless standard used for the access point. Combinations of 802.11a, 802.11n & 802.11ac can be selected.
Enable SSID Number	Select how many SSIDs to enable for the 5GHz frequency from the drop down menu. A maximum of 16 can be enabled.

SSID#	Enter the SSID name for the specified SSID (up to 16). The SSID can consist of any combination of up to 32 alphanumeric characters.
VLAN ID	Specify a VLAN ID for each SSID.
Auto Channel	Enable/disable auto channel selection. Auto channel selection will automatically set the wireless channel for the access point's 5GHz frequency based on availability and potential interference. When disabled, select a channel manually as shown in the next table.
Auto Channel Range	Select a range from which the auto channel setting (above) will choose a channel.
Auto Channel Interval	Specify a frequency for how often the auto channel setting will check/reassign the wireless channel. Check/uncheck the "Change channel even if clients are connected" box according to your preference.
Channel Bandwidth	Set the channel bandwidth: 20MHz (lower performance but less interference), Auto 40/20MHz or Auto 80/40/20MHz (automatically select based on interference level).
BSS BasicRate Set	Set a Basic Service Set (BSS) rate: this is a series of rates to control communication frames for wireless clients.

When auto channel is disabled, select a wireless channel manually:

Channel	Select a wireless channel.
Channel Bandwidth	Set the channel bandwidth: 20MHz (lower performance but less interference), Auto 40/20MHz or Auto 80/40/20MHz (automatically select based on interference level).
BSS BasicRate Set	Set a Basic Service Set (BSS) rate: this is a series of rates to control communication frames for wireless clients.

IV-6-3-2. Advanced

These settings are for experienced users only. Please do not change any of the values on this page unless you are already familiar with these functions.



Changing these settings can adversely affect the performance of your access point.

5GHz Advanced Settings	
Guard Interval	Short GI ▾
802.11n Protection	<input checked="" type="radio"/> Enable <input type="radio"/> Disable
DTIM Period	1 (1-255)
RTS Threshold	2347 (1-2347)
Fragment Threshold	2346 (256-2346)
Multicast Rate	Auto ▾
Tx Power	100% ▾
Beacon Interval	100 (40-1000 ms)
Station idle timeout	60 (30-65535 seconds)

Guard Interval	Set the guard interval. A shorter interval can improve performance.
802.11n Protection	Enable/disable 802.11n protection, which increases reliability but reduces bandwidth (clients will send Request to Send (RTS) to access point, and access point will broadcast Clear to Send (CTS), before a packet is sent from client.)
DTIM Period	Set the DTIM (delivery traffic indication message) period value of the wireless radio. The default value is 1.
RTS Threshold	Set the RTS threshold of the wireless radio. The default value is 2347.
Fragment Threshold	Set the fragment threshold of the wireless radio. The default value is 2346.
Multicast Rate	Set the transfer rate for multicast packets or use the "Auto" setting.
Tx Power	Set the power output of the wireless radio. You may not require 100% output power. Setting a lower power output can enhance security since potentially malicious/unknown users in distant areas will not be able to access your signal.

Beacon Interval	Set the beacon interval of the wireless radio. The default value is 100.
Station idle timeout	Set the interval for keepalive messages from the access point to a wireless client to verify if the station is still alive/active.

IV-6-3-3. Security

The access point provides various security options (wireless data encryption). When data is encrypted, information transmitted wirelessly cannot be read by anyone who does not know the correct encryption key.



It's essential to configure wireless security in order to prevent unauthorised access to your network.



Select hard-to-guess passwords which include combinations of numbers, letters and symbols, and change your password regularly.

5GHz Wireless Security Settings	
SSID	WAP1750-03EC1A_A ▼
Broadcast SSID	Enable ▼
Wireless Client Isolation	Disable ▼
Load Balancing	50 /50
Authentication Method	No Authentication ▼
Additional Authentication	No additional authentication ▼

SSID	Select which SSID to configure security settings for.
Broadcast SSID	Enable or disable SSID broadcast. When enabled, the SSID will be visible to clients as an available Wi-Fi network. When disabled, the SSID will not be visible as an available Wi-Fi network to clients – clients must manually enter the SSID in order to connect. A hidden (disabled) SSID is typically more secure than a visible (enabled) SSID.
Wireless Client Isolation	Enable or disable wireless client isolation. Wireless client isolation prevents clients connected to the access point from communicating with each other and improves security. Typically, this function is useful for corporate environments or public hot spots and can prevent brute force attacks on clients' usernames and passwords.

Load Balancing	Load balancing limits the number of wireless clients connected to an SSID. Set a load balancing value (maximum 50).
Authentication Method	Select an authentication method from the drop down menu and refer to the information below appropriate for your method.
Additional Authentication	Select an additional authentication method from the drop down menu and refer to the information below appropriate for your method.

Please refer back to **IV-6-2-3. Security** for more information on authentication and additional authentication types.

IV-6-3-4. WDS

Wireless Distribution System (WDS) can bridge/repeat access points together in an extended network. WDS settings can be configured as shown below.



When using WDS, configure the IP address of each access point to be in the same subnet and ensure there is only one active DHCP server among connected access points, preferably on the WAN side.

WDS must be configured on each access point, using correct MAC addresses. All access points should use the same wireless channel and encryption method.

5GHz WDS Mode	
WDS Functionality	Disabled
Local MAC Address	Disabled WDS with AP Dedicated WDS
WDS Peer Settings	
WDS #1	MAC Address <input type="text"/>
WDS #2	MAC Address <input type="text"/>
WDS #3	MAC Address <input type="text"/>
WDS #4	MAC Address <input type="text"/>
WDS VLAN	
VLAN Mode	Untagged Port <small>(Enter at least one MAC address.)</small>
VLAN ID	1
Encryption method	
Encryption	None <small>(Enter at least one MAC address.)</small>

5GHz WDS Mode	
WDS Functionality	Select “WDS with AP” to use WDS with access point or “WDS Dedicated Mode” to use WDS and also block communication with regular wireless clients. When WDS is used, each access point should be configured with corresponding MAC addresses, wireless channel and wireless encryption method.
Local MAC Address	Displays the MAC address of your access point.

WDS Peer Settings

WDS #	Enter the MAC address for up to four other WDA devices you wish to connect.
--------------	---

WDS VLAN	
VLAN Mode	Specify the WDS VLAN mode to “Untagged Port” or “Tagged Port”.
VLAN ID	Specify the WDS VLAN ID when “Untagged Port” is selected above.

WDS Encryption	
Encryption	Select whether to use “None” or “AES” encryption and enter a pre-shared key for AES with 8-63 alphanumeric characters.

IV-6-4. WPS

Wi-Fi Protected Setup is a simple way to establish connections between WPS compatible devices. WPS can be activated on compatible devices by pushing a WPS button on the device or from within the device's firmware/configuration interface (known as PBC or "Push Button Configuration"). When WPS is activated in the correct manner and at the correct time for two compatible devices, they will automatically connect. "PIN code WPS" is a variation of PBC which includes the additional use of a PIN code between the two devices for verification.



Please refer to manufacturer's instructions for your other WPS device.

WPS Enable

Apply

WPS

Product PIN: 02570501

Push-button WPS

WPS by PIN:

WPS Security

WPS Status: Configured

WPS	Check/uncheck this box to enable/disable WPS functionality. WPS must be disabled when using MAC-RADIUS authentication (see IV-6-2-3-6. & IV-6-5).
Product PIN	Displays the WPS PIN code of the device, used for PIN code WPS. You will be required to enter this PIN code into another WPS device for PIN code WPS. Click "Generate PIN" to generate a new WPS PIN code.
Push-Button WPS	Click "Start" to activate WPS on the access point for approximately 2 minutes. This has the same effect as physically pushing the access point's WPS button.
WPS by PIN	Enter the PIN code of another WPS device and click "Start" to attempt to establish a WPS connection for approximately 2 minutes.

WPS Status	WPS security status is displayed here. Click “Release” to clear the existing status.
-------------------	--

IV-6-5. RADIUS

The RADIUS sub menu allows you to configure the access point’s RADIUS server settings, categorized into three submenus: RADIUS settings, Internal Server and RADIUS accounts.

A RADIUS server provides user-based authentication to improve security and offer wireless client control – users can be authenticated before gaining access to a network.

The access point can utilize both a primary and secondary (backup) RADIUS server for each of its wireless frequencies (2.4GHz & 5GHz). External RADIUS servers can be used or the access point’s internal RADIUS server can be used.



To use RADIUS servers, go to “Local Network” → “Security” → “Additional Authentication” and select “MAC RADIUS Authentication” (see IV-6-2-3. & IV-6-3-3).

IV-6-5-1. RADIUS Settings

Configure the RADIUS server settings for 2.4GHz & 5GHz. Each frequency can use an internal or external RADIUS server.

RADIUS Server (2.4GHz)	
Primary RADIUS Server	
RADIUS Type	<input type="radio"/> Internal <input checked="" type="radio"/> External
RADIUS Server	<input type="text"/>
Authentication Port	<input type="text" value="1812"/>
Shared Secret	<input type="text"/>
Session Timeout	<input type="text" value="3600"/> second(s)
Accounting	<input checked="" type="radio"/> Enable <input type="radio"/> Disable
Accounting Port	<input type="text" value="1813"/>
Secondary RADIUS Server	
RADIUS Type	<input type="radio"/> Internal <input checked="" type="radio"/> External
RADIUS Server	<input type="text"/>
Authentication Port	<input type="text" value="1812"/>
Shared Secret	<input type="text"/>
Session Timeout	<input type="text" value="3600"/> second(s)
Accounting	<input checked="" type="radio"/> Enable <input type="radio"/> Disable
Accounting Port	<input type="text" value="1813"/>

RADIUS Server (5GHz)	
Primary RADIUS Server	
RADIUS Type	<input type="radio"/> Internal <input checked="" type="radio"/> External
RADIUS Server	<input type="text"/>
Authentication Port	<input type="text" value="1812"/>
Shared Secret	<input type="text"/>
Session Timeout	<input type="text" value="3600"/> second(s)
Accounting	<input checked="" type="radio"/> Enable <input type="radio"/> Disable
Accounting Port	<input type="text" value="1813"/>
Secondary RADIUS Server	
RADIUS Type	<input type="radio"/> Internal <input checked="" type="radio"/> External
RADIUS Server	<input type="text"/>
Authentication Port	<input type="text" value="1812"/>
Shared Secret	<input type="text"/>
Session Timeout	<input type="text" value="3600"/> second(s)
Accounting	<input checked="" type="radio"/> Enable <input type="radio"/> Disable
Accounting Port	<input type="text" value="1813"/>

RADIUS Type	Select “Internal” to use the access point’s built-in RADIUS server or “external” to use an external RADIUS server.
RADIUS Server	Enter the RADIUS server host IP address.
Authentication Port	Set the UDP port used in the authentication protocol of the RADIUS server. Value must be between 1 – 65535.
Shared Secret	Enter a shared secret/password between 1 – 99 characters in length. This should match the “MAC-RADIUS” password used in IV-3-1-3-6 or IV-3-2-3 .
Session Timeout	Set a duration of session timeout in seconds between 0 – 86400.
Accounting	Enable or disable RADIUS accounting.
Accounting Port	When accounting is enabled (above), set the UDP port used in the accounting protocol of the RADIUS server. Value must be between 1 – 65535.

IV-6-5-2. Internal Server

The access point features a built-in RADIUS server which can be configured as shown below used when “Internal” is selected for “RADIUS Type” in the “Local Network” → “RADIUS Settings” menu.



To use RADIUS servers, go to “Wireless Settings” → “Security” “Additional Authentication” and select “MAC RADIUS Authentication” (see IV-6-2-3. & IV-6-3-3).

Internal Server	
Internal Server	<input type="checkbox"/> Enable
EAP Internal Authentication	PEAP(MS-PEAP) ▼
EAP Certificate File Format	PKCS#12(*.pfx/*.p12)
EAP Certificate File	<input type="button" value="Upload"/>
Shared Secret	<input type="text"/>
Session-Timeout	<input type="text" value="3600"/> second(s)
Termination-Action	<input checked="" type="radio"/> Reauthentication (RADIUS-Request) <input type="radio"/> Not-Reauthentication (Default) <input type="radio"/> Not-Send

Internal Server	Check/uncheck to enable/disable the access point's internal RADIUS server.
EAP Internal Authentication	Select EAP internal authentication type from the drop down menu.
EAP Certificate File Format	Displays the EAP certificate file format: PCK#12(*.pfx/*.p12)
EAP Certificate File	Click "Upload" to open a new window and select the location of an EAP certificate file to use. If no certificate file is uploaded, the internal RADIUS server will use a self-made certificate.
Shared Secret	Enter a shared secret/password for use between the internal RADIUS server and RADIUS client. The shared secret should be 1 – 99 characters in length. This should match the "MAC-RADIUS" password used in IV-6-2-3-6 or IV-6-3-3 .
Session Timeout	Set a duration of session timeout in seconds between 0 – 86400.
Termination Action	Select a termination-action attribute: "Reauthentication" sends a RADIUS request to the access point, "Not-Reauthentication" sends a default termination-action attribute to the access point, "Not-Send" no termination-action attribute is sent to the access point.

IV-6-5-3. RADIUS Accounts

The internal RADIUS server can authenticate up to 256 user accounts. The “RADIUS Accounts” page allows you to configure and manage users.

RADIUS Accounts

User Name

Example: USER1, USER2, USER3, USER4

Enter username here

Add Reset

User Registration List

Select	User Name	Password	Customize
<input type="checkbox"/>	Edimax	Not Configured	Edit

Delete Selected Delete All

Edit User Registration List

User Name Edimax (4-16characters)

Password (6-32characters)

User Name	Enter the user names here, separated by commas.
Add	Click “Add” to add the user to the user registration list.
Reset	Clear text from the user name box.

Select	Check the box to select a user.
User Name	Displays the user name.
Password	Displays if specified user name has a password (configured) or not (not configured).
Customize	Click “Edit” to open a new field to set/edit a password for the specified user name (below).

Delete Selected	Delete selected user from the user registration list.
Delete All	Delete all users from the user registration list.

Edit User Registration List

User Name	Existing user name is displayed here and can be edited according to your preference.
Password	Enter or edit a password for the specified user.

IV-6-6. MAC Filter

Mac filtering is a security feature that can help to prevent unauthorized users from connecting to your access point.

This function allows you to define a list of network devices permitted to connect to the access point. Devices are each identified by their unique MAC address. If a device which is not on the list of permitted MAC addresses attempts to connect to the access point, it will be denied.

 **To enable MAC filtering, go to “Local Settings” → “Security” → “Additional Authentication” and select “MAC Filter” (see IV-6-2-3. & IV-6-3-3).**

The MAC address filtering table is displayed below:

Add MAC Addresses

Add
Reset

MAC Address Filtering Table

Select	MAC Address
<input type="checkbox"/>	FC:F8:AE:43:43:7E

Delete Selected
Delete All
Export

Add MAC Address

Enter a MAC address of computer or network device manually e.g. 'aa-bb-cc-dd-ee-ff' or enter multiple MAC addresses separated with

	commas, e.g. 'aa-bb-cc-dd-ee-ff,aa-bb-cc-dd-ee-gg'
Add	Click "Add" to add the MAC address to the MAC address filtering table.
Reset	Clear all fields.

MAC address entries will be listed in the "MAC Address Filtering Table". Select an entry using the "Select" checkbox.

Select	Delete selected or all entries from the table.
MAC Address	The MAC address is listed here.
Delete Selected	Delete the selected MAC address from the list.
Delete All	Delete all entries from the MAC address filtering table.
Export	Click "Export" to save a copy of the MAC filtering table. A new window will pop up for you to select a location to save the file.

IV-6-7. WMM

Wi-Fi Multimedia (WMM) is a Wi-Fi Alliance interoperability certification based on the IEEE 802.11e standard, which provides Quality of Service (QoS) features to IEEE 802.11 networks. WMM prioritizes traffic according to four categories: background, best effort, video and voice.

WMM-EDCA Settings				
WMM Parameters of Access Point				
	CWMin	CWMax	AIFSN	TxOP
Back Ground	4	10	7	0
Best Effort	4	6	3	0
Video	3	4	1	94
Voice	2	3	1	47
WMM Parameters of Station				
	CWMin	CWMax	AIFSN	TxOP
Back Ground	4	10	7	0
Best Effort	4	10	3	0
Video	3	4	2	94
Voice	2	3	2	47

Configuring WMM consists of adjusting parameters on queues for different categories of wireless traffic. Traffic is sent to the following queues:

Background	Low Priority	High throughput, non time sensitive bulk data e.g. FTP
Best Effort	Medium Priority	Traditional IP data, medium throughput and delay.
Video	High Priority	Time sensitive video data with minimum time delay.
Voice	High Priority	Time sensitive data such as VoIP and streaming media with minimum time delay.

Queues automatically provide minimum transmission delays for video, voice, multimedia and critical applications. The values can further be adjusted manually:

CWMin	Minimum Contention Window (milliseconds): This value is input to the initial random backoff wait time algorithm for retry of a data frame transmission. The backoff wait time will
--------------	--

	be generated between 0 and this value. If the frame is not sent, the random backoff value is doubled until the value reaches the number defined by CWMax (below). The CWMin value must be lower than the CWMax value. The contention window scheme helps to avoid frame collisions and determine priority of frame transmission. A shorter window has a higher probability (priority) of transmission.
CWMax	Maximum Contention Window (milliseconds): This value is the upper limit to random backoff value doubling (see above).
AIFSN	Arbitration Inter-Frame Space (milliseconds): Specifies additional time between when a channel goes idle and the AP/client sends data frames. Traffic with a lower AIFSN value has a higher priority.
TxOP	Transmission Opportunity (milliseconds): The maximum interval of time an AP/client can transmit. This makes channel access more efficiently prioritized. A value of 0 means only one frame per transmission. A greater value effects higher priority.

IV-7. Local Settings

IV-7-1. Operation Mode

Set the operation mode of the access point. AP mode is a standalone access point, AP controller mode acts as the designated master of the AP array, and Managed AP mode acts as a slave AP within the AP array.

Operation Mode

Operation Mode

AP Controller Mode ▾

AP Mode

AP Controller Mode

Managed AP mode

IV-7-2. Network Settings

IV-7-2-1. System Information

The “System Information” page displays basic system information about the access point.

System	
Model	WAP1750
Product Name	AP74DA3803EC1A
Uptime	0 day 20:01:40
Boot from	Internal memory
Version	0.9.12
MAC Address	74:DA:38:03:EC:1A
Management VLAN ID	1
IP Address	192.168.222.220
Default Gateway	192.168.222.1
DNS	---
DHCP Server	---

Wired LAN Port Settings

Wired LAN Port	Status	VLAN Mode/ID
Wired Port (#1)	Connected (1000 Mbps Full-Duplex)	Untagged Port / 1
Wired Port (#2)	Disconnected (---)	Untagged Port / 1

Wireless 2.4GHz

Status	Enabled
MAC Address	74:DA:38:03:EC:1A
Channel	Ch 6 (Auto)
Transmit Power	100%

Wireless 2.4GHz /SSID

SSID	Authentication Method	Encryption Type	VLAN ID	Additional Authentication	Wireless Client Isolation
AMPED_DNS_TEST	WPA/WPA2-PSK	TKIP/AES Mixed Mode	1	No additional authentication	Disabled

Wireless 2.4GHz /WDS Disabled

MAC Address	Encryption Type	VLAN Mode/ID
No WDS entries.		

System	
Model	Displays the model number of the access point.
Product Name	Displays the product name for reference, which consists of "AP" plus the MAC address.
Uptime	Displays the total time since the device was turned on.
Boot From	Displays information for the booted hardware, booted from either USB or internal memory.
Version	Displays the firmware version.
MAC Address	Displays the access point's MAC address.
Management VLAN ID	Displays the management VLAN ID.
IP Address	Displays the IP address of this device. Click "Refresh" to update this value.
Default Gateway	Displays the IP address of the default gateway.
DNS	IP address of DNS (Domain Name Server)
DHCP Server	IP address of DHCP Server.

Wired LAN Port Settings	
Wired LAN Port	Specifies which LAN port (1 or 2).
Status	Displays the status of the specified LAN port (connected or disconnected).

VLAN Mode/ID	Displays the VLAN mode (tagged or untagged) and VLAN ID for the specified LAN port. See IV-6-1-3. VLAN
---------------------	---

Wireless 2.4GHz (5GHz)	
Status	Displays the status of the 2.4GHz or 5GHz wireless (enabled or disabled).
MAC Address	Displays the access point's MAC address.
Channel	Displays the channel number the specified wireless frequency is using for broadcast.
Transmit Power	Displays the wireless radio transmit power level as a percentage.

Wireless 2.4GHZ (5GHz) / SSID	
SSID	Displays the SSID name(s) for the specified frequency.
Authentication Method	Displays the authentication method for the specified SSID. See IV-6. Wireless Settings
Encryption Type	Displays the encryption type for the specified SSID. See IV-6. Wireless Settings
VLAN ID	Displays the VLAN ID for the specified SSID. See IV-6-1-3. VLAN
Additional Authentication	Displays the additional authentication type for the specified SSID. See IV-6. Wireless Settings
Wireless Client Isolation	Displays whether wireless client isolation is in use for the specified SSID. See IV-6-1-3. VLAN

Wireless 2.4GHZ (5GHz) / WDS Status	
MAC Address	Displays the peer access point's MAC address.
Encryption Type	Displays the encryption type for the specified WDS. See IV-6-2-4. WDS
VLAN Mode/ID	Displays the VLAN ID for the specified WDS. See IV-6-2-4. WDS

Refresh	Click to refresh all information.
----------------	-----------------------------------

IV-7-2-2. Wireless Clients

The “Wireless Clients” page displays information about all wireless clients connected to the access point on the 2.4GHz or 5GHz frequency.

Refresh time									
Auto Refresh time		<input checked="" type="radio"/> 5 seconds <input type="radio"/> 1 second <input type="radio"/> Disable							
Manual Refresh		<input type="button" value="Refresh"/>							

2.4GHz WLAN Client Table									
#	SSID	MAC Address	Tx	Rx	Signal (%)	Connected Time	Idle Time	Vendor	
1	AMPED_DNS_TEST	F8:7B:8C:1F:2D:61	3.6 KBytes	7.6 MBytes	100	14 hours 29 min 30 secs	0	Amped Wireless	

5GHz WLAN Client Table									
#	SSID	MAC Address	Tx	Rx	Signal (%)	Connected Time	Idle Time	Vendor	
No wireless client									

Refresh time	
Auto Refresh Time	Select a time interval for the client table list to automatically refresh.
Manual Refresh	Click refresh to manually refresh the client table.

2.4GHz (5GHz) WLAN Client Table	
SSID	Displays the SSID which the client is connected to.
MAC Address	Displays the MAC address of the client.
Tx	Displays the total data packets transmitted by the specified client.
Rx	Displays the total data packets received by the specified client.
Signal (%)	Displays the wireless signal strength for the specified client.
Connected Time	Displays the total time the wireless client has been connected to the access point.
Idle Time	Client idle time is the time for which the client has not transmitted any data packets i.e. is idle.
Vendor	The vendor of the client’s wireless adapter is displayed here.

IV-7-2-3. Wireless Monitor

Wireless Monitor is a tool built into the access point to scan and monitor the surrounding wireless environment. Select a frequency and click “Scan” to display a list of all SSIDs within range along with relevant details for each SSID.

Wireless Monitor	
Site Survey	<input checked="" type="radio"/> Wireless 2.4G/ 5G <input type="radio"/> 2.4G <input type="radio"/> 5G <input type="button" value="Scan"/>
Channel Survey result	<input type="button" value="Export"/>

Wireless 2.4GHz (112 Accesspoints)						
Ch	SSID	MAC Address	Security	Signal (%)	Type	Vendor
1		00:18:0A:D3:4C:F0	WPA1PSKWPA2PSK /TKIPAES	84	b/g/n	Meraki, Inc.
1	111111	00:AA:BB:02:01:E0	NONE	97	b/g/n	Unknown
1	13213136	26:DA:38:00:20:40	NONE	98	b/g/n	Unknown
1	22222	02:AA:BB:02:01:E0	NONE	96	b/g/n	Unknown
1	EA3500-2.4G	C8:D7:19:2C:9F:1F	WPA2PSK/AES	100	b/g/n	Cisco Consumer Products, LLC

Wireless Monitor	
Site Survey	Select which frequency (or both) to scan, and click “Scan” to begin.
Channel Survey Result	After a scan is complete, click “Export” to save the results to local storage.

Site Survey Results	
Ch	Displays the channel number used by the specified SSID.
SSID	Displays the SSID identified by the scan.
MAC Address	Displays the MAC address of the wireless router/access point for the specified SSID.
Security	Displays the authentication/encryption type of the specified SSID.
Signal (%)	Displays the current signal strength of the SSID.
Type	Displays the 802.11 wireless networking standard(s) of the specified SSID.
Vendor	Displays the vendor of the wireless router/access point for the specified SSID.

IV-7-2-4. Log

The system log displays system operation information such as up time and connection processes. This information is useful for network administrators.



When the log is full, old entries are overwritten.

```
Jan 1 00:00:51 [SYSTEM]: WLAN[2.4G], Best channel selection start, switch to channel 6
Jan 1 00:00:47 [SYSTEM]: WLAN[2.4G], Best channel selection start, switch to channel 6
Jan 1 00:00:15 [NMS]: start AP Controller successfully
Jan 1 00:00:14 [NMS]: NMS version: 0.9.12.1
Jan 1 00:00:14 [SYSTEM]: Auto Pilot, Stopping
Jan 1 00:00:14 [SYSTEM]: FTP Server, start
Jan 1 00:00:14 [SYSTEM]: TELNETD, start Telnet-cli Server
Jan 1 00:00:14 [SYSTEM]: HTTPS, start
Jan 1 00:00:14 [SYSTEM]: HTTP, start
Jan 1 00:00:13 [SYSTEM]: LAN, Firewall Disabled
Jan 1 00:00:13 [SYSTEM]: LAN, NAT Disabled
Jan 1 00:00:13 [SYSTEM]: NET, Firewall Disabled
Jan 1 00:00:13 [SYSTEM]: NET, NAT Disabled
Jan 1 00:00:13 [SYSTEM]: LEDs, light on specific LEDs
Jan 1 00:00:11 [SYSTEM]: WLAN[5G], Channel = AutoSelect
Jan 1 00:00:11 [SYSTEM]: WLAN[5G], Wireless Mode = 11ACVHT80
Jan 1 00:00:03 [SYSTEM]: WLAN[2.4G], Channel = AutoSelect
Jan 1 00:00:03 [SYSTEM]: WLAN[2.4G], Wireless Mode = 11NGHT40MINUS
Jan 1 00:00:03 [SYSTEM]: LAN, IP address=192.168.222.220
Jan 1 00:00:03 [SYSTEM]: LAN, start
Jan 1 00:00:02 [SYSTEM]: Bridge, start
Jan 1 00:00:02 [SYSTEM]: Bridge, start
Jan 1 00:00:00 [SYSTEM]: SYS, Model Name: Wireless Gigabit Router
Jan 1 00:00:00 [SYSTEM]: SYS, Application Version: 0.9.12
Jan 1 00:00:00 [SYSTEM]: BOOT, WAP1750
```

Save	Click to save the log as a file on your local computer.
Clear	Clear all log entries.
Refresh	Refresh the current log.

The following information/events are recorded by the log:

- ◆ **USB**
Mount & unmount
- ◆ **Wireless Client**
Connected & disconnected
Key exchange success & fail
- ◆ **Authentication**
Authentication fail or successful.
- ◆ **Association**
Success or fail
- ◆ **WPS**
M1 - M8 messages
WPS success
- ◆ **Change Settings**
- ◆ **System Boot**
Displays current model name
- ◆ **NTP Client**
- ◆ **Wired Link**
LAN Port link status and speed status
- ◆ **Proxy ARP**
Proxy ARP module start & stop
- ◆ **Bridge**
Bridge start & stop.
- ◆ **SNMP**
SNMP server start & stop.
- ◆ **HTTP**
HTTP start & stop.
- ◆ **HTTPS**
HTTPS start & stop.
- ◆ **SSH**
SSH-client server start & stop.
- ◆ **Telnet**
Telnet-client server start or stop.
- ◆ **WLAN (2.4G)**
WLAN (2.4G) channel status and country/region status
- ◆ **WLAN (5G)**
WLAN (5G) channel status and country/region status
- ◆ **ADT**

IV-7-3. Management

IV-7-3-1. Admin

You can change the password used to login to the browser-based configuration interface here. It is advised to do so for security purposes.



If you change the administrator password, please make a note of the new password. In the event that you forget this password and are unable to login to the browser based configuration interface, see IV-7-4-4. Factory Default for how to reset the access point.

Account to Manage This Device	
Administrator Name	<input type="text" value="admin"/>
Administrator Password	<input type="password" value="****"/> (4-32 Characters)
	<input type="password" value="****"/> (Confirm)
<input type="button" value="Apply"/>	

Advanced Settings	
Product Name	<input type="text" value="AP74DA3803EC1A"/>
Management Protocol	<input checked="" type="checkbox"/> HTTP <input checked="" type="checkbox"/> HTTPS <input checked="" type="checkbox"/> TELNET <input type="checkbox"/> SSH <input type="checkbox"/> SNMP
SNMP Version	<input type="text" value="v1/v2c"/>
SNMP Get Community	<input type="text" value="public"/>
SNMP Set Community	<input type="text" value="private"/>
SNMP Trap	<input type="text" value="Disabled"/>
SNMP Trap Community	<input type="text" value="public"/>
SNMP Trap Manager	<input type="text" value=""/>
<input type="button" value="Apply"/>	

Account to Manage This Device	
Administrator Name	Set the access point's administrator name. This is used to log in to the browser based configuration interface and must be between 4-16 alphanumeric characters (case sensitive).
Administrator Password	Set the access point's administrator password. This is used to log in to the browser based configuration interface and must be between 4-32 alphanumeric characters (case sensitive).

Advanced Settings	
Product Name	Edit the product name according to your preference consisting of 1-32 alphanumeric characters. This name is used for reference purposes.
Management Protocol	Check/uncheck the boxes to enable/disable specified management interfaces (see below). When SNMP is enabled, complete the SNMP fields below.
SNMP Version	Select SNMP version appropriate for your SNMP manager.
SNMP Get Community	Enter an SNMP Get Community name for verification with the SNMP manager for SNMP-GET requests.
SNMP Set Community	Enter an SNMP Set Community name for verification with the SNMP manager for SNMP-SET requests.
SNMP Trap	Enable or disable SNMP Trap to notify SNMP manager of network errors.
SNMP Trap Community	Enter an SNMP Trap Community name for verification with the SNMP manager for SNMP-TRAP requests.
SNMP Trap Manager	Specify the IP address or sever name (2-128 alphanumeric characters) of the SNMP manager.

HTTP

Internet browser HTTP protocol management interface

HTTPS

Internet browser HTTPS protocol management interface

TELNET

Client terminal with telnet protocol management interface

SSH

Client terminal with SSH protocol version 1 or 2 management interface

SNMP

Simple Network Management Protocol. SNMPv1, v2 & v3 protocol supported. SNMPv2 can be used with community based authentication. SNMPv3 uses user-based security model (USM) architecture.

IV-7-3-2. Date and Time

You can configure the time zone settings of your access point here. The date and time of the device can be configured manually or can be synchronized with a time server.

Date and Time Settings	
Local Time	2012 ▼ Year Jan ▼ Month 1 ▼ Day 0 ▼ Hours 00 ▼ Minutes 00 ▼ Seconds
<input type="button" value="Acquire Current Time from Your PC"/>	
NTP Time Server	
Use NTP	<input type="checkbox"/> Enable
Server Name	<input type="text"/>
Update Interval	24 (Hours)
Time Zone	
Time Zone	(GMT-06:00) Central Time (US & Canada) ▼

Date and Time Settings	
Local Time	Set the access point's date and time manually using the drop down menus.
Acquire Current Time from your PC	Click "Acquire Current Time from Your PC" to enter the required values automatically according to your computer's current time and date.

NTP Time Server	
Use NTP	The access point also supports NTP (Network Time Protocol) for automatic time and date setup.
Server Name	Enter the host name or IP address of the time server if you wish.
Update Interval	Specify a frequency (in hours) for the access point to update/synchronize with the NTP server.

Time Zone	
Time Zone	Select the time zone of your country/ region. If your country/region is not listed, please select another country/region whose time zone is the same as yours.

IV-7-3-3. Syslog Server

The system log can be sent to a server, attached to USB storage or sent via email.

Syslog Server Settings	
Transfer Logs	<input type="checkbox"/> Enable Syslog Server <input type="text"/>
Copy Logs to Attached USB Device	<input type="checkbox"/> Enable

Syslog E-mail Settings	
E-mail Logs	<input checked="" type="checkbox"/>
E-mail Subject	<input type="text"/>
SMTP Server Address	<input type="text"/>
SMTP Server Port	<input type="text"/>
Sender E-mail	<input type="text"/>
Receiver E-mail	<input type="text"/>
Authentication	SSL ▾
Account	Disable
Password	SSL
	TLS

Syslog Server Settings	
Transfer Logs	Check/uncheck the box to enable/disable the use of a syslog server, and enter a host name, domain or IP address for the server, consisting of up to 128 alphanumeric characters.
Copy Logs to Attached USB Device	Check/uncheck the box to enable/disable copying logs to attached USB storage.

Syslog Email Settings	
Email Logs	Check/uncheck the box to enable/disable email logs. When enabled, the log will be emailed according to the settings below.
Email Subject	Enter the subject line of the email which will be sent containing the log.
SMTP Server Address	Specify the SMTP server address for the sender email account.
SMTP Server Port	Specify the SMTP server port for the sender email account.
Sender Email	Enter the sender's email address.
Receiver Email	Specify the email recipient of the log.
Authentication	Select "Disable", "SSL" or "TLS" according to

	your email authentication.
Account	When authentication is used above, enter the account name.
Password	When authentication is used above, enter the password.

IV-7-3-4. I'm Here

The access point features a built-in buzzer which can sound on command using the "I'm Here" page. This is useful for network administrators and engineers working in complex network environments to locate the access point.

Duration of Sound	
Duration of Sound	<input type="text" value="10"/> (1-300 seconds)



The buzzer is loud!

Duration of Sound	Set the duration for which the buzzer will sound when the "Sound Buzzer" button is clicked.
Sound Buzzer	Activate the buzzer sound for the above specified duration of time.

IV-7-4. Advanced

Wi-Fi Multimedia (WMM) is a Wi-Fi Alliance interoperability certification based on the IEEE 802.11e standard, which provides Quality of Service (QoS) features to IEEE 802.11 networks. WMM prioritizes traffic according to four categories: background, best effort, video and voice.

IV-7-4-1. LED Settings

The access point's LEDs can be manually enabled or disabled according to your preference.

LED Settings	
Power LED	<input checked="" type="radio"/> On <input type="radio"/> Off
Diag LED	<input checked="" type="radio"/> On <input type="radio"/> Off

Power LED	Select on or off.
Diag LED	Select on or off.

IV-7-4-2. Update Firmware

The “Firmware” page allows you to update the system firmware to a more recent version. Updated firmware versions often offer increased performance and security, as well as bug fixes. You can download the latest firmware from the Edimax website.



This firmware update is for an individual access point. To update firmware for multiple access points in the AP array, go to NMS Settings → Firmware Upgrade.

Firmware Location	
Update firmware from	<input checked="" type="radio"/> a file on your PC <input type="radio"/> a file on an attached USB device (No USB device connected.)

Update firmware from PC	
Firmware Update File	<input type="button" value="Choose File"/> No file chosen
<input type="button" value="Update"/>	



Do not switch off or disconnect the access point during a firmware upgrade, as this could damage the device.

Update Firmware From	Select “a file on your PC” to upload firmware from your local computer or from an attached USB device.
Firmware Update File	Click “Browse” to open a new window to locate and select the firmware file in your computer.
Update	Click “Update” to upload the specified firmware file to your access point.

IV-7-4-3. Save/Restore Settings

The access point's "Save/Restore Settings" page enables you to save/backup the access point's current settings as a file to your local computer or a USB device attached to the access point, and restore the access point to previously saved settings.

Save / Restore Settings

Using Device

Select "Using your PC" to save the access point's settings to your local computer or to an attached USB device.

Save Settings to PC

Save Settings

Click "Save" to save settings and a new window will open to specify a location to save the settings file. You can also check the "Encrypt the configuration file with a password" box and enter a password to protect the file in the field underneath, if you wish.

Restore Settings from PC

Restore Settings

Click the browse button to find a previously saved settings file on your computer, then click "Restore" to replace your current settings. If your settings file is encrypted with a password, check the "Open file with

	password” box and enter the password in the field underneath.
--	---

IV-7-4-4. Factory Default

If the access point malfunctions or is not responding, then it is recommended that you reboot the device (see **IV-7-4-5.**) or reset the device back to its factory default settings. You can reset the access point back to its default settings using this feature if the location of the access point is not convenient to access the reset button.

This will restore all settings to factory defaults.

Factory Default

Factory Default	Click “Factory Default” to restore settings to the factory default. A pop-up window will appear and ask you to confirm.
------------------------	---



After resetting to factory defaults, please wait for the access point to reset and restart.

IV-7-4-5. Reboot

If the access point malfunctions or is not responding, then it is recommended that you reboot the device or reset the access point back to its factory default settings (see **IV-7-4-4.**) You can reboot the access point remotely using this feature.

This will reboot the product. Your settings will not be changed. Click “Reboot” to reboot the product now.

Reboot

Reboot	Click “Reboot” to reboot the device. A countdown will indicate the progress of the reboot.
---------------	--

IV-8. Toolbox

IV-8-1. Network Connectivity

IV-8-1-1. Ping

Ping is a computer network administration utility used to test whether a particular host is reachable across an IP network and to measure the round-trip time for sent messages.

Destination Address	Enter the address of the host.
Execute	Click execute to ping the host.

IV-8-1-2. Trace Route

Traceroute is a diagnostic tool for displaying the route (path) and measuring transit delays of packets across an IP network.

Destination Address	Enter the address of the host.
Execute	Click execute to execute the traceroute command.

V. Appendix

V-1. Configuring your IP address

The access point uses the default IP address **192.168.2.2**. In order to access the browser based configuration interface, you need to modify the IP address of your computer to be in the same IP address subnet e.g. **192.168.2.x (x = 3 – 254)**.

The procedure for modifying your IP address varies across different operating systems; please follow the guide appropriate for your operating system.

In the following examples we use the IP address **192.168.2.10** though you can use any IP address in the range **192.168.2.x (x = 3 – 254)**.



If you changed the AP Controller's IP address, or if your gateway/router uses a DHCP server, ensure you enter the correct IP address. Refer to your gateway/router's settings. Your computer's IP address must be in the same subnet as the AP Controller.



If using a DHCP server on the network, it is advised to use your DHCP server's settings to assign the AP Controller a static IP address.

V-1-1. Windows XP

1. Click the “Start” button (it should be located in the lower-left corner of your computer), then click “Control Panel”. Double-click the “Network and Internet Connections” icon, click “Network Connections”, and then double-click “Local Area Connection”. The “Local Area Connection Status” window will then appear, click “Properties”.

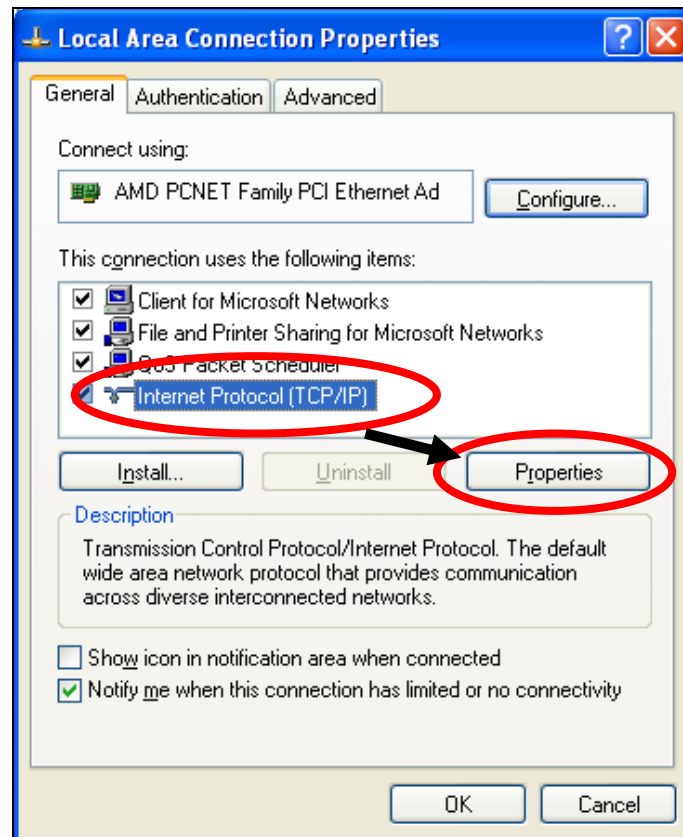

2. Select “Use the following IP address”, then input the following values:

IP address: 192.168.2.10

Subnet Mask: 255.255.255.0

Click ‘OK’ when finished.

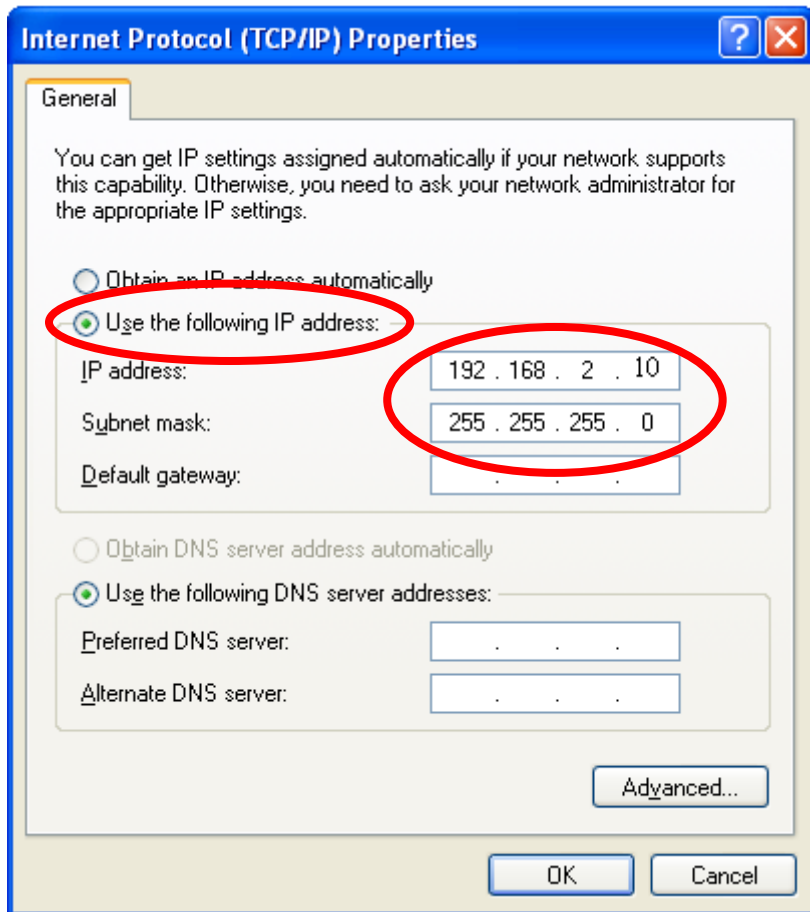

V-1-2. Windows Vista

1. Click the “Start” button (it should be located in the lower-left corner of your computer), then click “Control Panel”. Click “View Network Status and Tasks”, then click “Manage Network Connections”. Right-click “Local Area Network”, then select “Properties”. The “Local Area Connection Properties” window will then appear, select “Internet Protocol Version 4 (TCP / IPv4)”, and then click “Properties”.

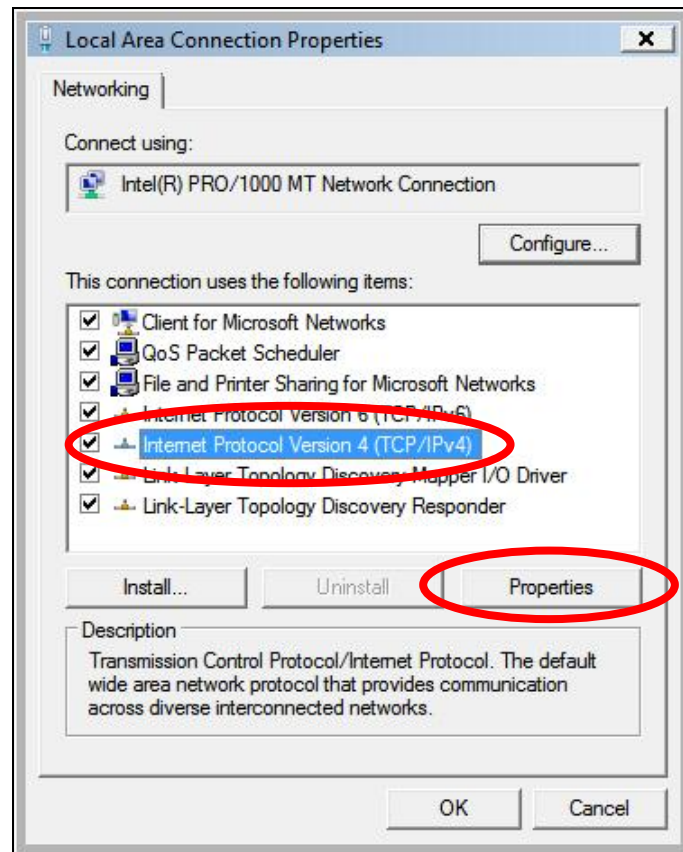

2. Select “Use the following IP address”, then input the following values:

IP address: 192.168.2.10

Subnet Mask: 255.255.255.0

Click ‘OK’ when finished.

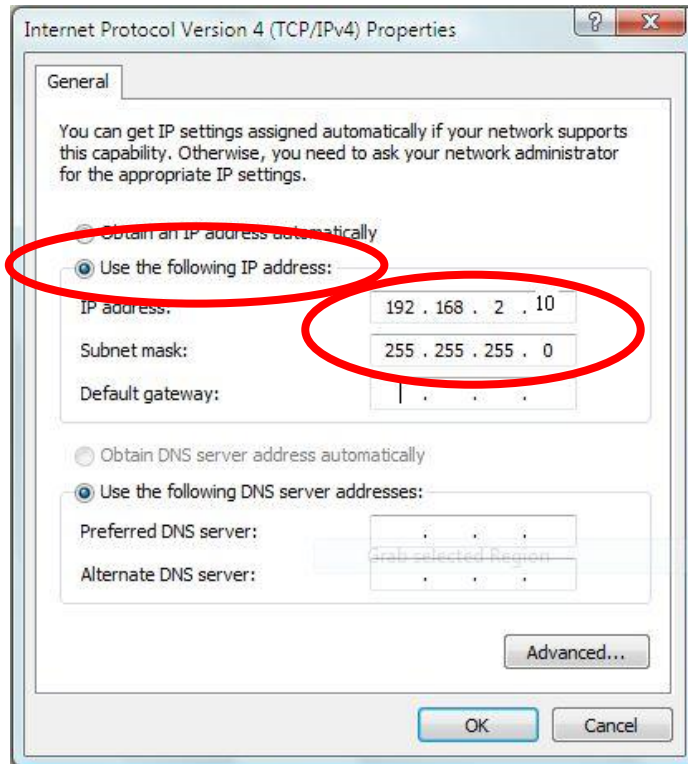

V-1-3. Windows 7

1. Click the “Start” button (it should be located in the lower-left corner of your computer), then click “Control Panel”.

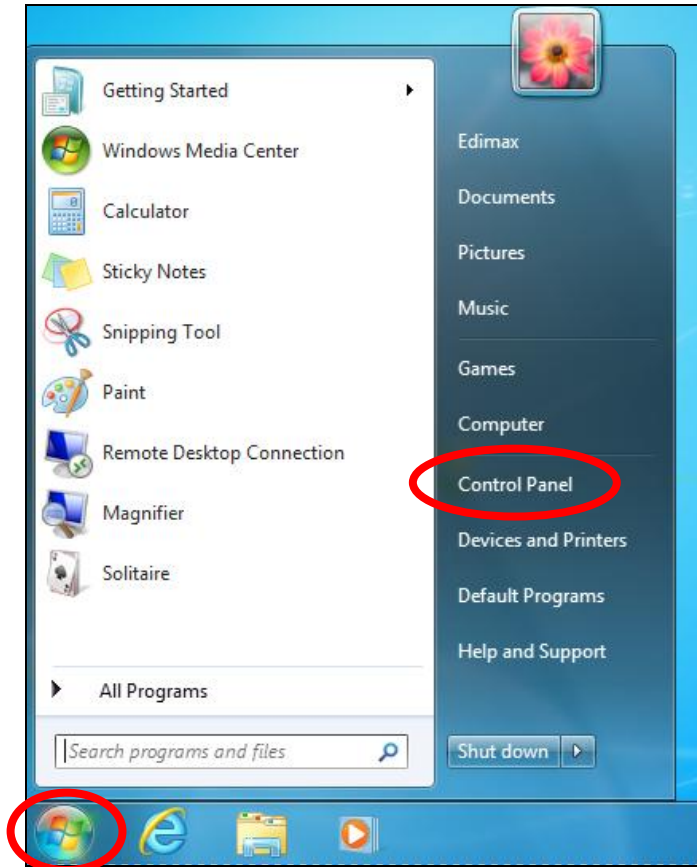

2. Under “Network and Internet” click “View network status and tasks”.

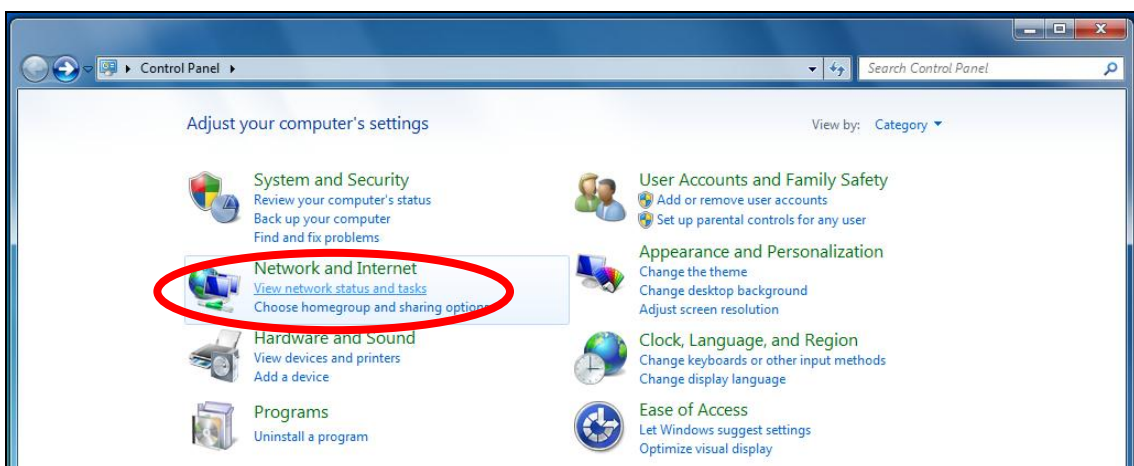

3. Click “Local Area Connection”.

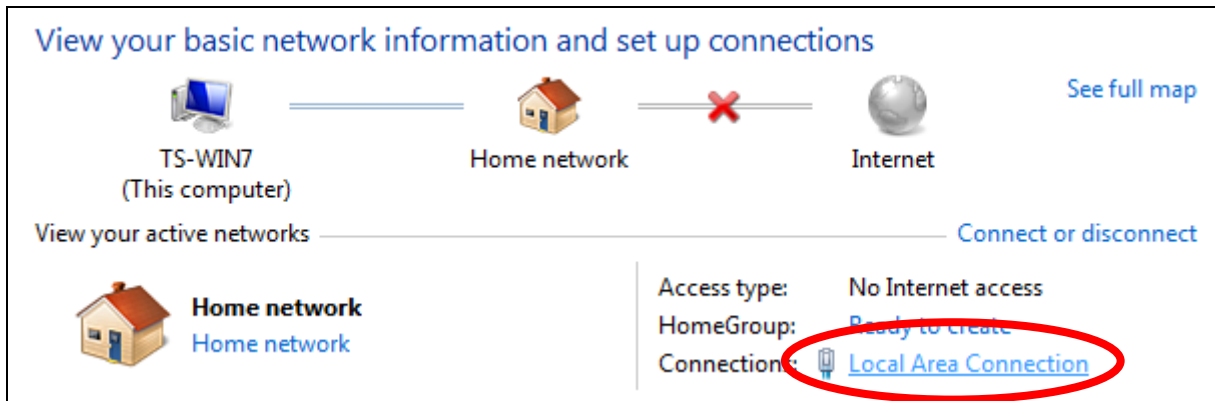

4. Click "Properties".

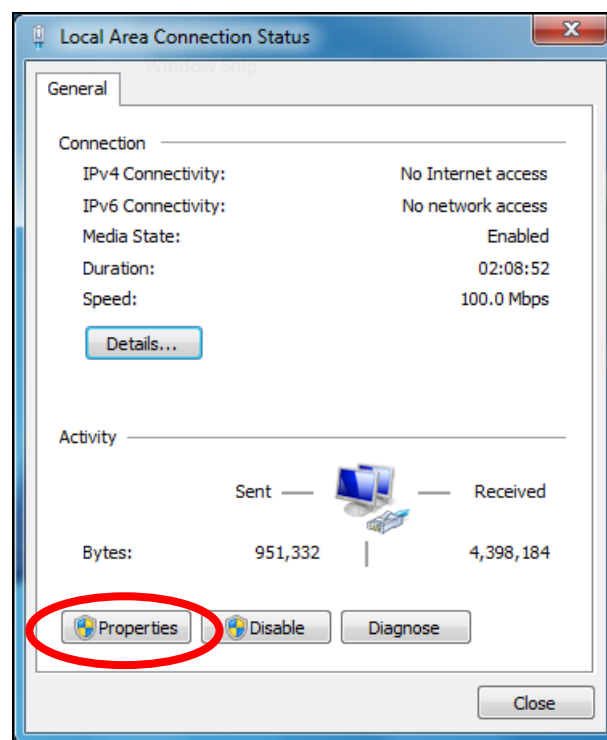

5. Select “Internet Protocol Version 4 (TCP/IPv4)” and then click “Properties”.

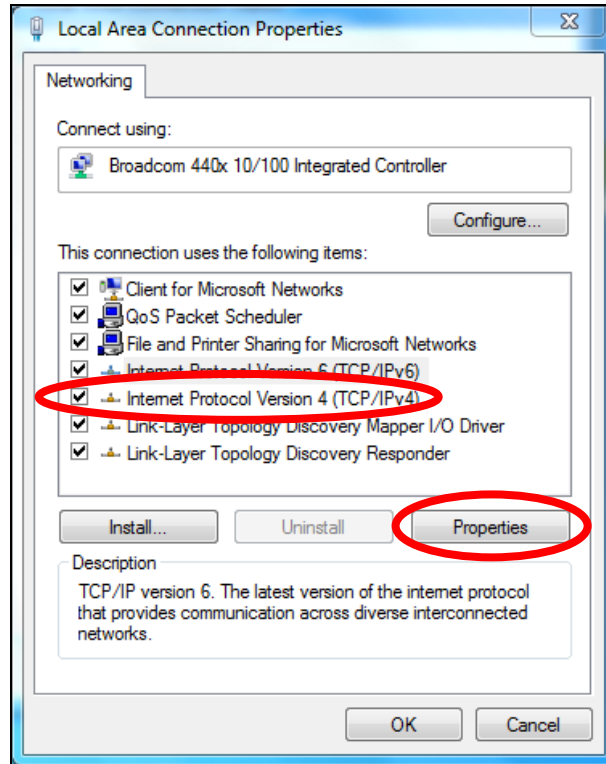

6. Select “Use the following IP address”, then input the following values:

IP address: 192.168.2.10

Subnet Mask: 255.255.255.0

Click ‘OK’ when finished.

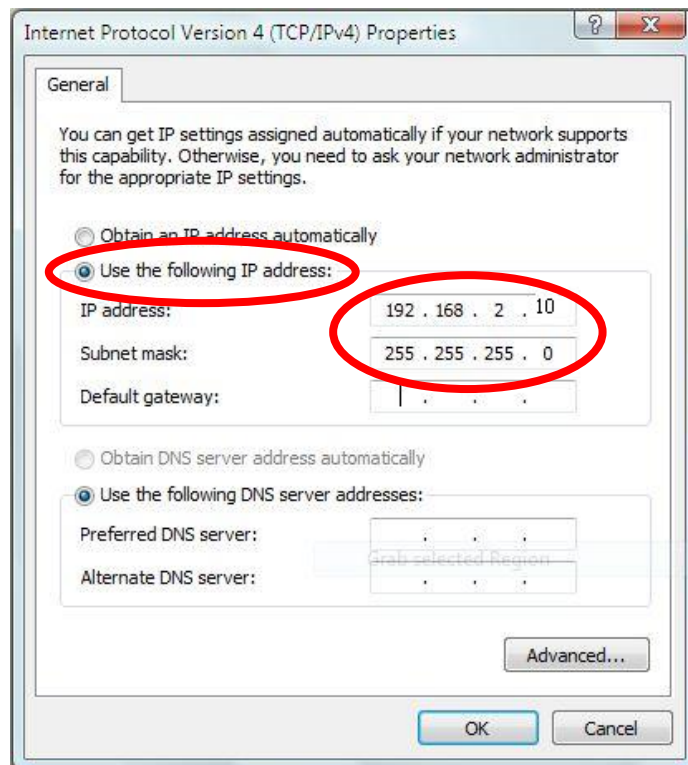

V-1-4. Windows 8

1. From the Windows 8 Start screen, you need to switch to desktop mode. Move your cursor to the bottom left of the screen and click.

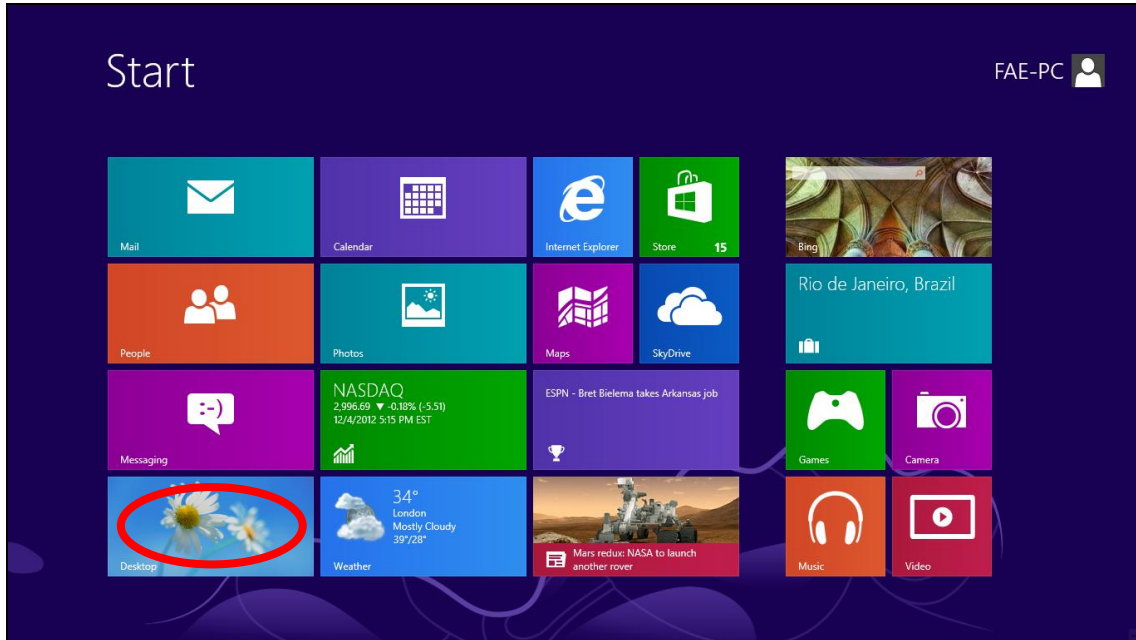

2. In desktop mode, click the File Explorer icon in the bottom left of the screen, as shown below.

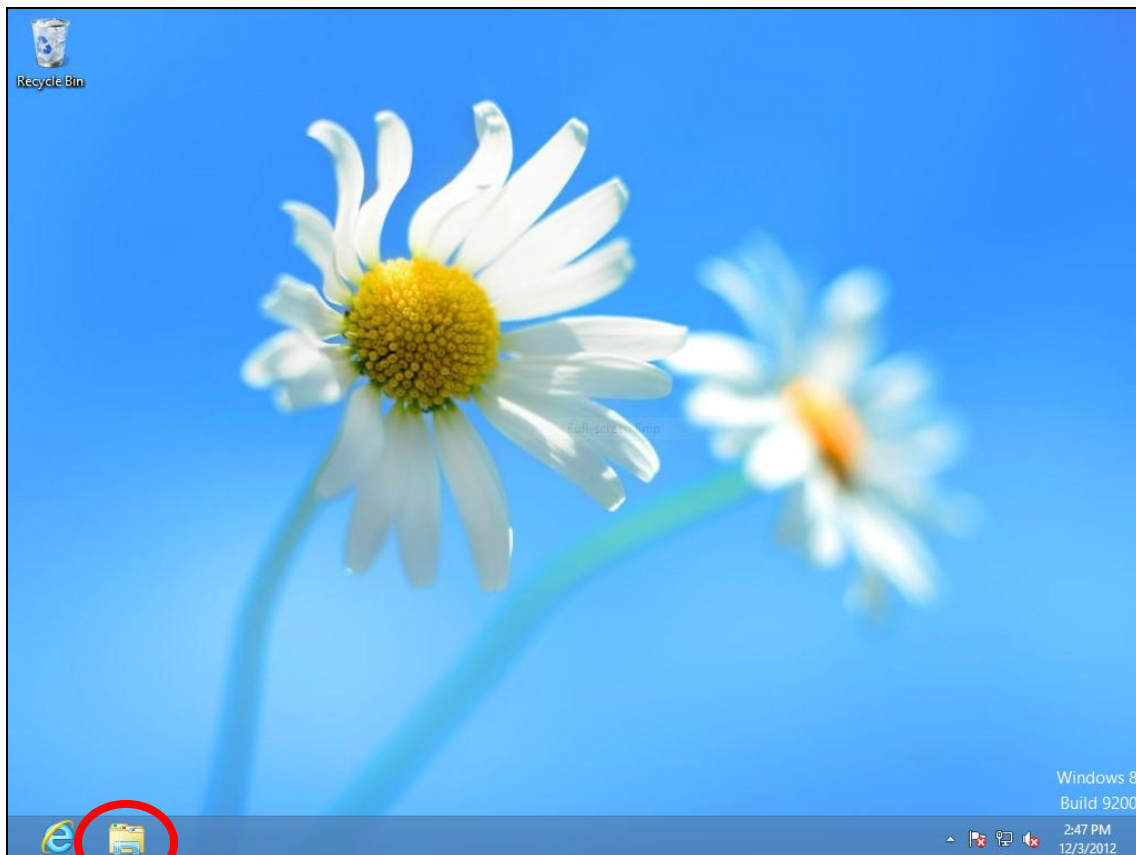

3. Right click “Network” and then select “Properties”.

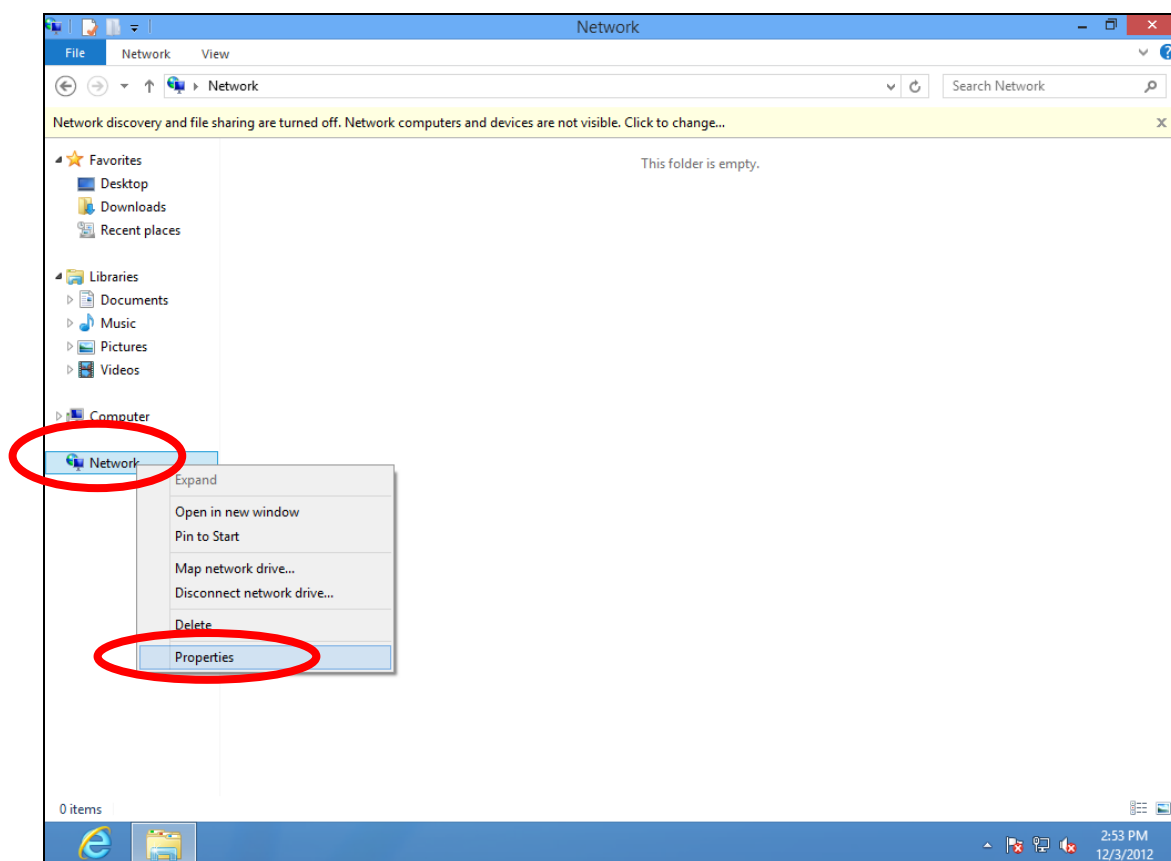

4. In the window that opens, select “Change adapter settings” from the left side.

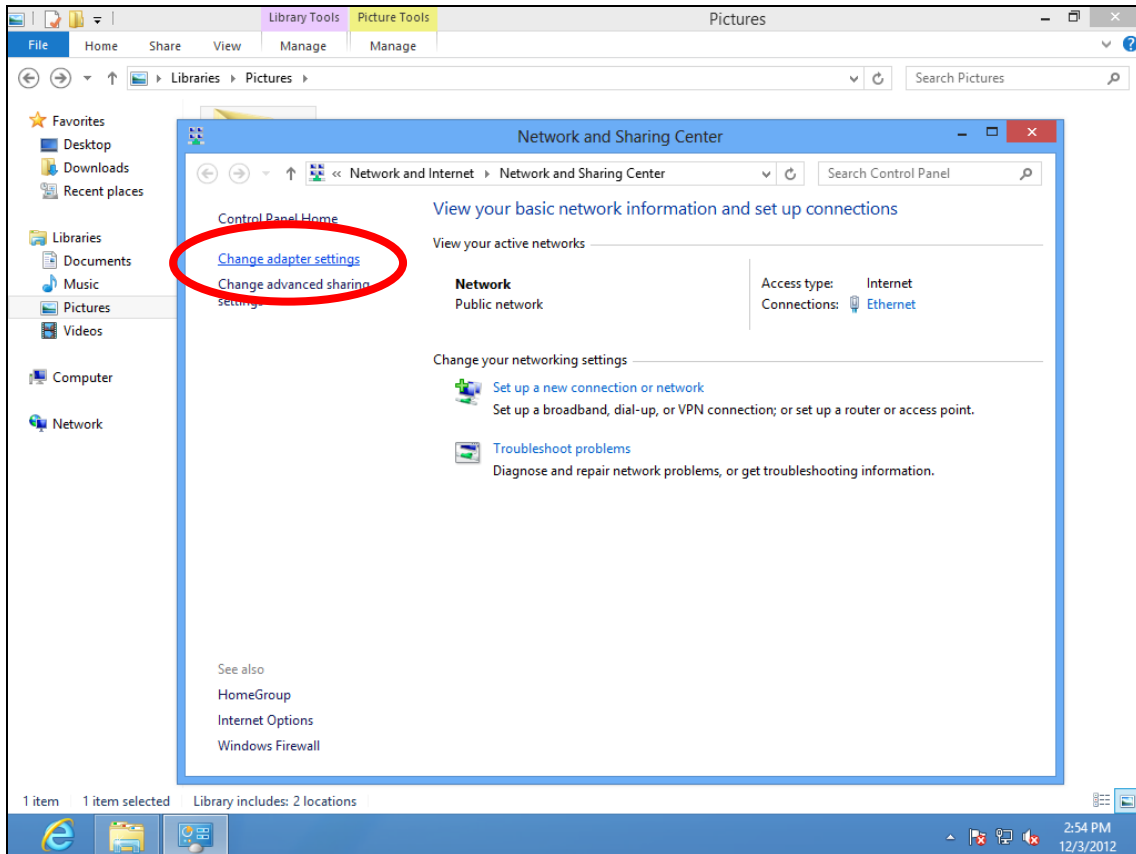

5. Choose your connection and right click, then select “Properties”.

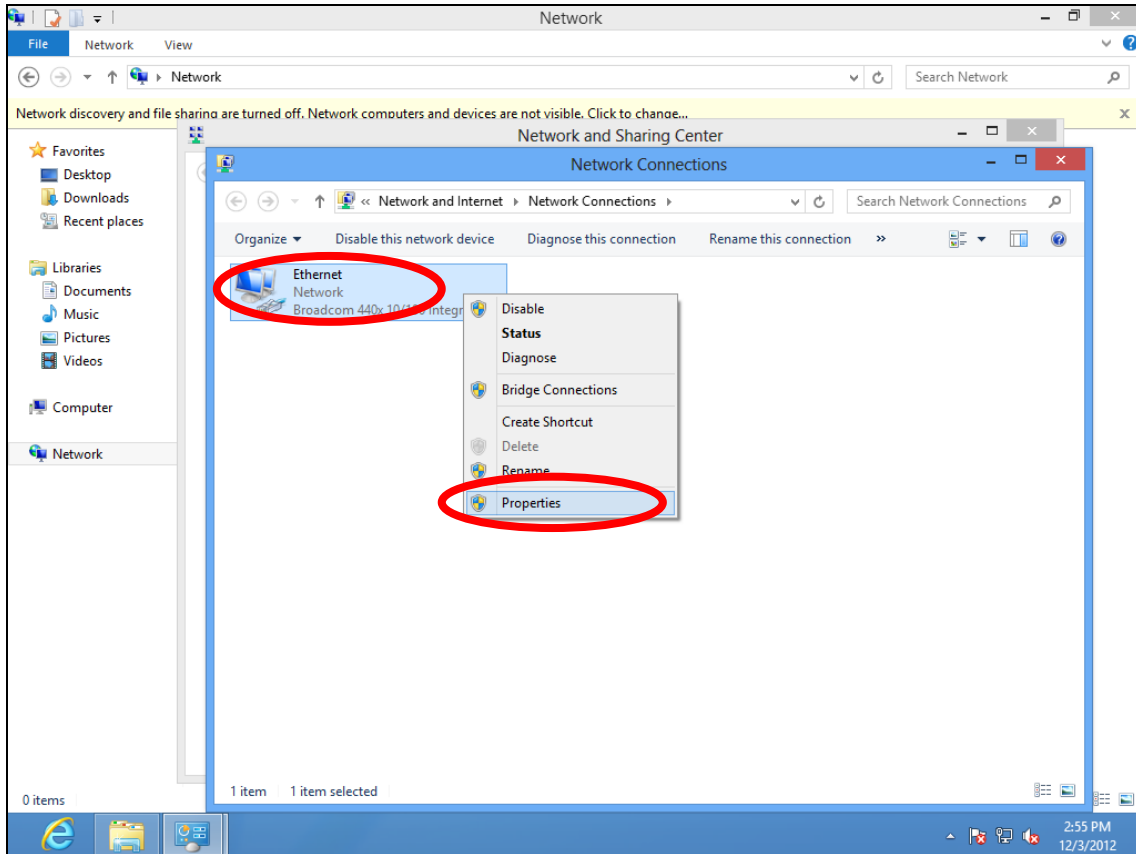

6. Select “Internet Protocol Version 4 (TCP/IPv4)” and then click “Properties”.

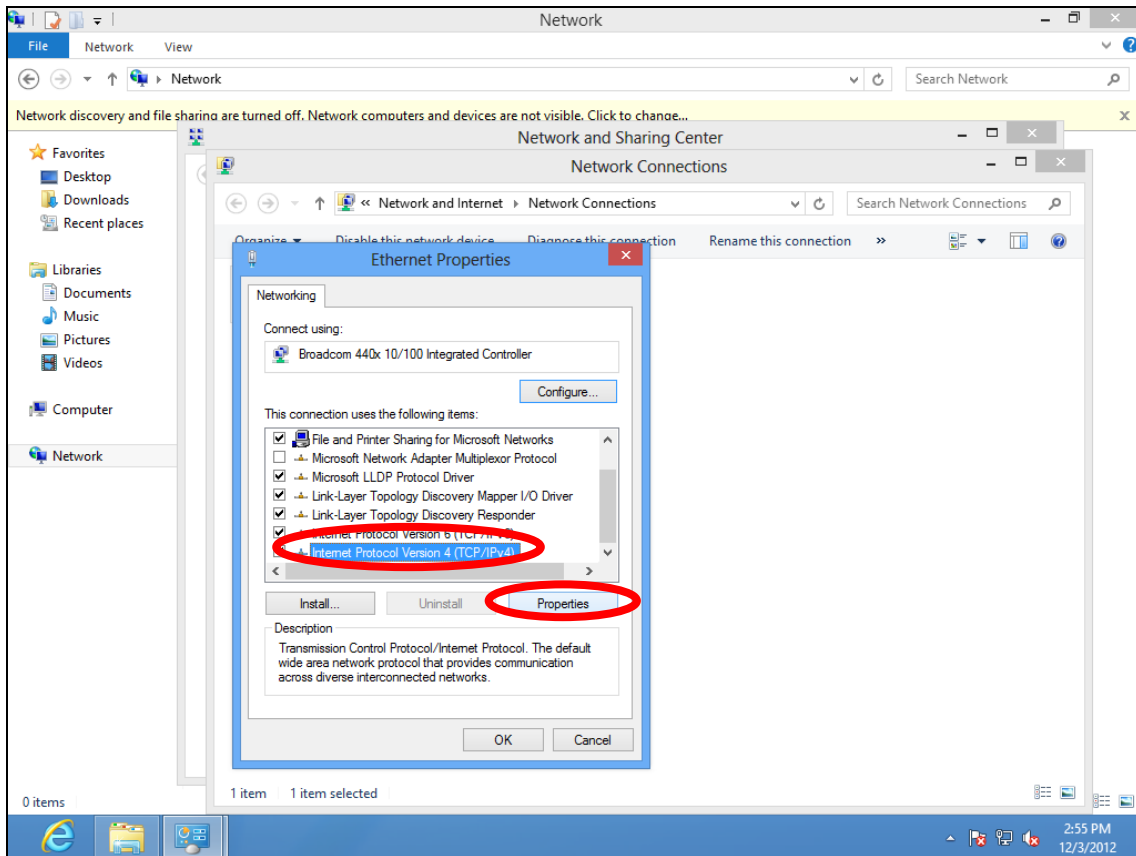

7. Select “Use the following IP address”, then input the following values:

IP address: 192.168.2.10

Subnet Mask: 255.255.255.0

Click ‘OK’ when finished.

V-1-5. Mac

1. Have your Macintosh computer operate as usual, and click on “System Preferences”

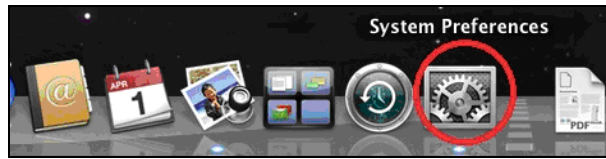

2. In System Preferences, click on “Network”.



3. Click on “Ethernet” in the left panel.

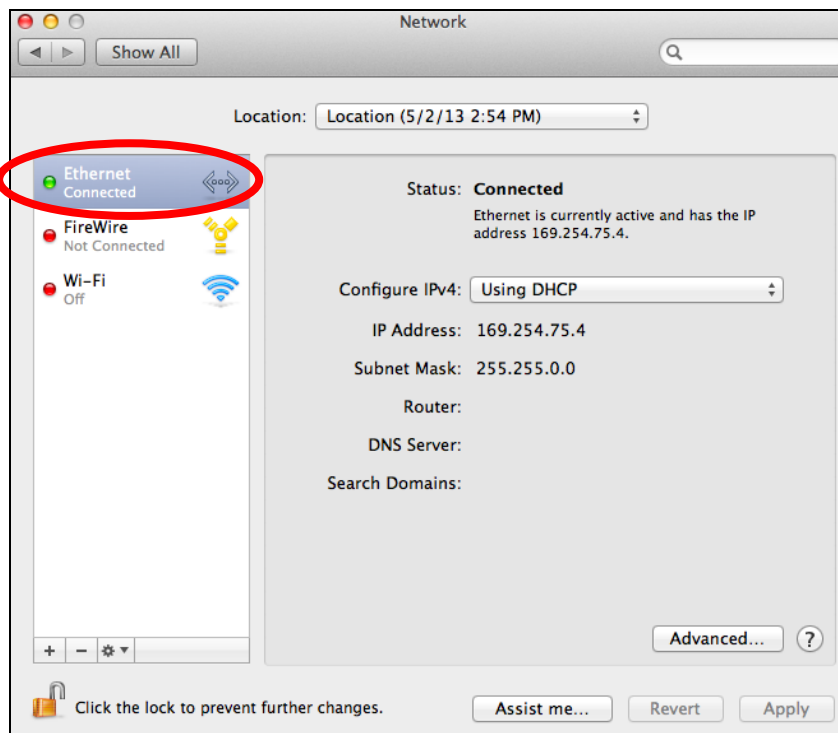

4. Open the drop-down menu labeled “Configure IPv4” and select “Manually”.

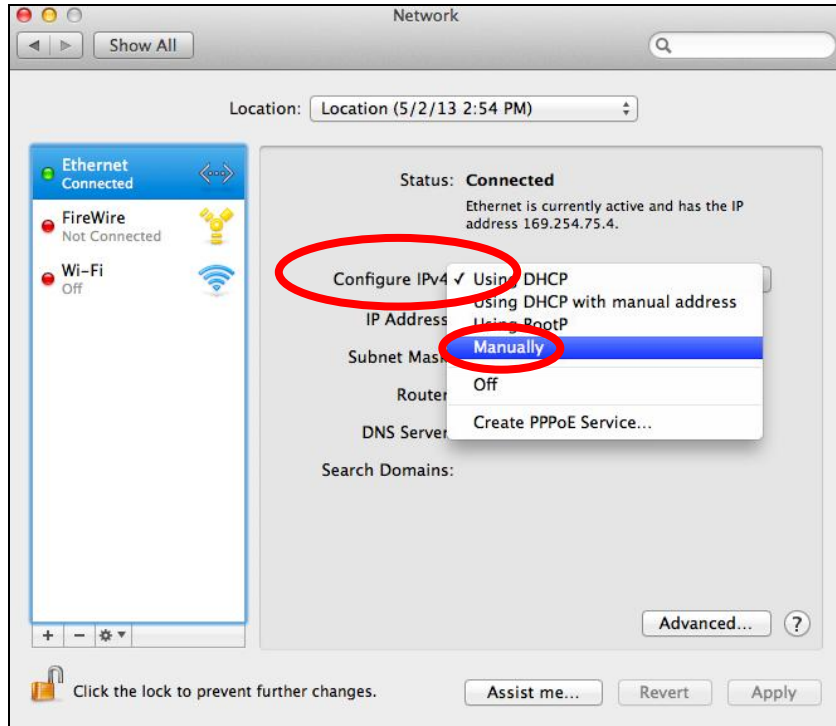

5. Enter the IP address 192.168.2.10 and subnet mask 255.255.255.0. Click on “Apply” to save the changes.

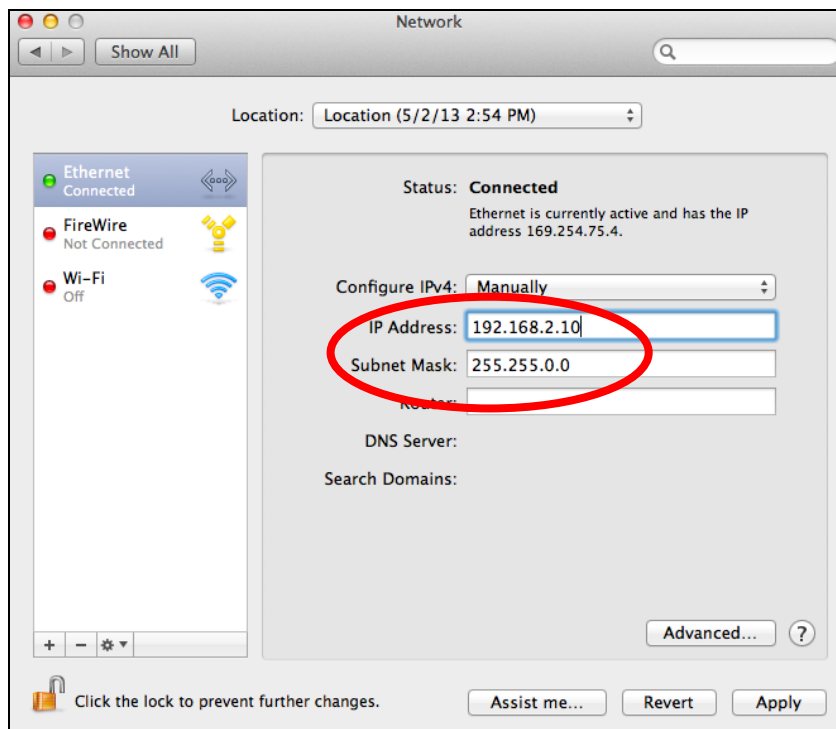

V. Best Practice

VI-1. How to Create and Link WLAN & Access Point Groups

You can use NMS to create individual SSIDs and group multiple SSIDs together into WLAN groups. You can then assign individual access points to use those WLAN group settings and/or group multiple access points together into access point groups, which you can also assign to use WLAN group settings.

Follow the example below to:

- A. Create a WLAN group.
- B. Create an access point group.
- C. Assign the access point group to use the SSID group settings.

- A.
 - 1. Go to **NMS Settings** → **WLAN** and click **“Add”** in the **WLAN** panel:

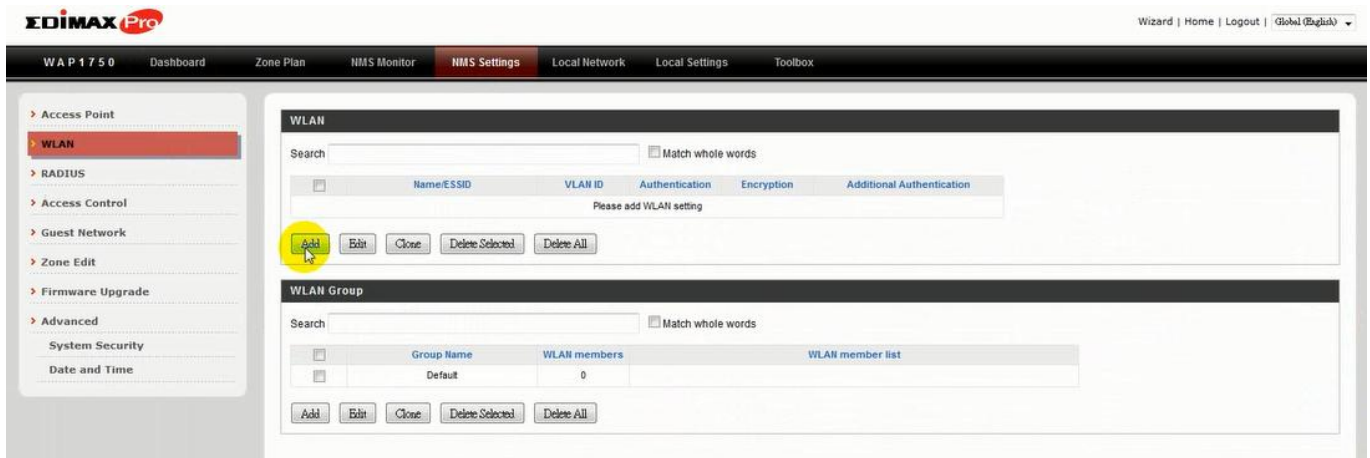

- 2. Enter an SSID name and set authentication/encryption and click **“Apply”**:

WAP1750 Dashboard Zone Plan NMS Monitor **NMS Settings** Local Network Local Settings Toolbox

> Access Point
WLAN
> RADIUS
> Access Control
> Guest Network
> Zone Edit
> Firmware Upgrade
> Advanced
System Security
Date and Time

WLAN Settings

Name/ESSID	EDIMAX_SSID1
Description	
VLAN ID	1
Broadcast SSID	Enable
Wireless Client Isolation	Disable
Load Balancing	50 /50
Authentication Method	WPA-PSK
WPA Type	WPA/WPA2 Mixed Mode-PSK
Encryption Type	TKIP/AES Mixed Mode
Key Renewal Interval	60 minute(s)
Pre-shared Key Type	Passphrase
Pre-shared Key	1234567890
Additional Authentication	No additional authentication

WLAN Advanced Settings

Smart Handover Settings	
Smart Handover	<input type="radio"/> Enable <input checked="" type="radio"/> Disable
RSSI Threshold	-80 dB

3. The new SSID will be displayed in the **WLAN** panel. **Repeat** to add additional SSIDs according to your preference, and then click **“Add”** in the **WLAN Group** panel:

EDIMAX Pro Wizard | Home | Logout | Global (English)

WAP1750 Dashboard Zone Plan NMS Monitor **NMS Settings** Local Network Local Settings Toolbox

> Access Point
WLAN
> RADIUS
> Access Control
> Guest Network
> Zone Edit
> Firmware Upgrade
> Advanced
System Security
Date and Time

WLAN

Search Match whole words

<input type="checkbox"/>	Name/ESSID	VLAN ID	Authentication	Encryption	Additional Authentication
<input type="checkbox"/>	EDIMAX_SSID1	1	WPA1-PSK,WPA2-PSK	TKIP,AES	No additional authentication
<input type="checkbox"/>	EDIMAX_SSID2	1	WPA1-PSK,WPA2-PSK	TKIP,AES	No additional authentication
<input type="checkbox"/>	EDIMAX_SSID3	1	OPEN	NONE	No additional authentication

WLAN Group

Search Match whole words

<input type="checkbox"/>	Group Name	WLAN members	WLAN member list
<input type="checkbox"/>	Default	0	

4. Enter a **name** for the **SSID group** and **check the boxes** to select which SSIDs to include within the group. Click **“Apply”** when done.



5. The new **WLAN group** will be displayed in the **WLAN Group** panel.
Repeat to add additional WLAN groups according to your preference:

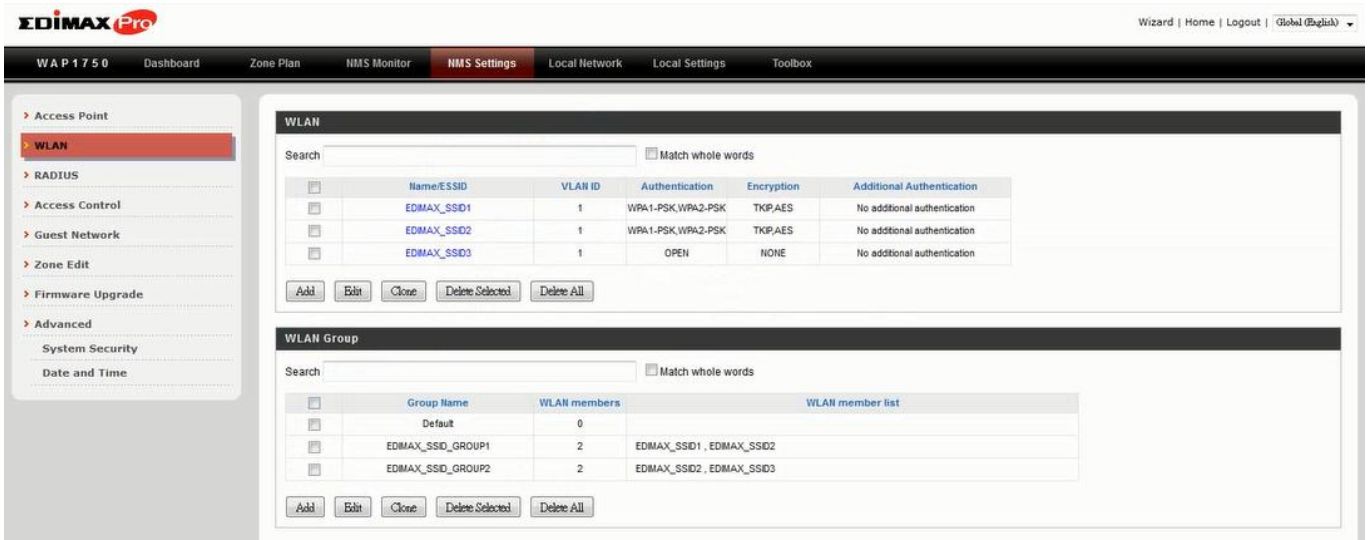

- B.**
1. Go to **NMS Settings** → **Access Point** and click “Add” in the Access Point Group Panel:

Access Point

Search Match whole words

<input type="checkbox"/>	MAC Address	Device Name	Model	AP Group	2.4G Channel	5G Channel	2.4G TX Power	5G TX Power	Status	Action
<input type="checkbox"/>	00-AA-BB-CC-DD-70	AP00AABCCDD70	WAP1750	System Default	11	36	Full	Full		
<input type="checkbox"/>	74-DA-38-03-B5-32	AP74DA3803B532	WAP1750	System Default	11	36	Full	Full		
<input type="checkbox"/>	74-DA-38-00-00-24	AP74DA38000024	WAP1750	System Default	11	36	Full	Full		
<input type="checkbox"/>	80-1F-02-75-ED-BF	AP801F0275EDBF	WAP1750	System Default	11	36	Full	Full		
<input type="checkbox"/>	00-AA-BB-CC-DD-60	AP00AABCCDD60	WAP1750	System Default	11	36	Full	Full		
<input type="checkbox"/>	00-AA-BB-CC-DD-22	AP00AABCCDD22	WAP1750	System Default	11	36	Full	Full		
<input type="checkbox"/>	74-DA-38-00-20-40	AP74DA38002040	WAP1750	System Default	11	36	Full	Full		
<input type="checkbox"/>	74-DA-38-03-23-9C	AP74DA3803239C	WAP1750	System Default	11	36	Full	Full		

Refresh Edit Delete Selected Delete All

Access Point Group

Search Match whole words

<input type="checkbox"/>	Group Name	AP Members	2.4G WLAN Profile	5G WLAN Profile	2.4G Guest Network Profile	5G Guest Network Profile	RADIUS Profile	Access Control Profile
<input type="checkbox"/>	System Default	8	Default	Default	Disabled	Disabled	Default	Default

Add Edit Clone Delete Selected Delete All

Access Point Settings

Auto Approve Enable Disable

Apply

- Enter a **Name** and then scroll down to the **Group Settings** panel and use the << button to **add** selected access points into your group from the box on the right side. Click **“Apply”** when done.

Profile Group Settings

Radio B/G/N (2.4 GHz) Override Group Setting

Radio A/N (5.0 GHz) Override Group Setting

WLAN Group Override Group Setting

Guest Network Group Override Group Setting

RADIUS Group Override Group Setting

Access Control Group Override Group Setting

Group Settings

Group Name: EDIMAX_SF

Search

MAC Address	Device Name
00-AA-BB-CC-DD-70	AP00AABCCDD70
74-DA-38-03-B5-32	AP74DA3803B532

Members

Search

System Default

MAC Address	Device Name
74-DA-38-00-00-24	AP74DA38000024
80-1F-02-75-ED-BF	AP801F0275EDBF
00-AA-BB-CC-DD-60	AP00AABCCDD60
00-AA-BB-CC-DD-22	AP00AABCCDD22
74-DA-38-00-20-40	AP74DA38002040
74-DA-38-03-23-9C	AP74DA3803239C

Apply Cancel

- The new **access point group** will be displayed in the **Access Point Group** panel. **Repeat** to add additional access point groups according to your preference:

WAP1750 Dashboard Zone Plan NMS Monitor **NMS Settings** Local Network Local Settings Toolbox

Access Point

WLAN
RADIUS
Access Control
Guest Network
Zone Edit
Firmware Upgrade
Advanced
System Security
Date and Time

Access Point

Search Match whole words

<input type="checkbox"/>	MAC Address	Device Name	Model	AP Group	2.4G Channel	5G Channel	2.4G TX Power	5G TX Power	Status	Action
<input type="checkbox"/>	00-AA-BB-CC-DD-70	AP00AABCCDD070	WAP1750	EDIMAX_SF	11	36	Full	Full	●	
<input type="checkbox"/>	74-DA-38-03-B5-32	AP74DA3803B532	WAP1750	EDIMAX_SF	11	36	Full	Full	●	
<input type="checkbox"/>	74-DA-38-00-00-24	AP74DA38000024	WAP1750	EDIMAX_SF	11	36	Full	Full	●	
<input type="checkbox"/>	80-1F-02-75-ED-BF	AP801F0275EDBF	WAP1750	EDIMAX_6F	11	36	Full	Full	●	
<input type="checkbox"/>	00-AA-BB-CC-DD-60	AP00AABCCDD060	WAP1750	EDIMAX_6F	11	36	Full	Full	●	
<input type="checkbox"/>	00-AA-BB-CC-DD-22	AP00AABCCDD022	WAP1750	EDIMAX_6F	11	36	Full	Full	●	
<input type="checkbox"/>	74-DA-38-00-20-40	AP74DA38002040	WAP1750	EDIMAX_6F	11	36	Full	Full	●	
<input type="checkbox"/>	74-DA-38-03-23-9C	AP74DA3803239C	WAP1750	EDIMAX_6F	11	36	Full	Full	●	

Refresh Edit Delete Selected Delete All

Access Point Group

Search Match whole words

<input type="checkbox"/>	Group Name	AP Members	2.4G WLAN Profile	5G WLAN Profile	2.4G Guest Network Profile	5G Guest Network Profile	RADIUS Profile	Access Control Profile
<input type="checkbox"/>	System Default	0	Default	Default	Disabled	Disabled	Default	Default
<input type="checkbox"/>	EDIMAX_SF	3	Default	Default	Disabled	Disabled	Default	Default
<input type="checkbox"/>	EDIMAX_6F	5	Default	Default	Disabled	Disabled	Default	Default

Add Edit Clone Delete Selected Delete All

Access Point Settings

Auto Approve Enable Disable

C.

1. Go to **NMS Settings** → **Access Point** and select an access point group using the checkboxes in the **Access Point Group** panel. Click “Edit”:

WAP1750 Dashboard Zone Plan NMS Monitor **NMS Settings** Local Network Local Settings Toolbox

Access Point

WLAN
RADIUS
Access Control
Guest Network
Zone Edit
Firmware Upgrade
Advanced
System Security
Date and Time

Access Point

Search Match whole words

<input type="checkbox"/>	MAC Address	Device Name	Model	AP Group	2.4G Channel	5G Channel	2.4G TX Power	5G TX Power	Status	Action
<input type="checkbox"/>	00-AA-BB-CC-DD-70	AP00AABCCDD070	WAP1750	EDIMAX_SF	11	36	Full	Full	●	
<input type="checkbox"/>	74-DA-38-03-B5-32	AP74DA3803B532	WAP1750	EDIMAX_SF	11	36	Full	Full	●	
<input type="checkbox"/>	74-DA-38-00-00-24	AP74DA38000024	WAP1750	EDIMAX_SF	11	36	Full	Full	●	
<input type="checkbox"/>	80-1F-02-75-ED-BF	AP801F0275EDBF	WAP1750	EDIMAX_6F	11	36	Full	Full	●	
<input type="checkbox"/>	00-AA-BB-CC-DD-60	AP00AABCCDD060	WAP1750	EDIMAX_6F	11	36	Full	Full	●	
<input type="checkbox"/>	00-AA-BB-CC-DD-22	AP00AABCCDD022	WAP1750	EDIMAX_6F	11	36	Full	Full	●	
<input type="checkbox"/>	74-DA-38-00-20-40	AP74DA38002040	WAP1750	EDIMAX_6F	11	36	Full	Full	●	
<input type="checkbox"/>	74-DA-38-03-23-9C	AP74DA3803239C	WAP1750	EDIMAX_6F	11	36	Full	Full	●	

Refresh Edit Delete Selected Delete All

Access Point Group

Search Match whole words

<input type="checkbox"/>	Group Name	AP Members	2.4G WLAN Profile	5G WLAN Profile	2.4G Guest Network Profile	5G Guest Network Profile	RADIUS Profile	Access Control Profile
<input type="checkbox"/>	System Default	0	Default	Default	Disabled	Disabled	Default	Default
<input checked="" type="checkbox"/>	EDIMAX_SF	3	Default	Default	Disabled	Disabled	Default	Default
<input type="checkbox"/>	EDIMAX_6F	5	Default	Default	Disabled	Disabled	Default	Default

Add Edit Clone Delete Selected Delete All

Access Point Settings

Auto Approve Enable Disable

2. Scroll down to the **Profile Group Settings** panel and check the “**Override Group Settings**” box for **WLAN Group (2.4GHz and/or 5GHz)**. Select your **WLAN group** from the drop-down menu and click “**Apply**”:

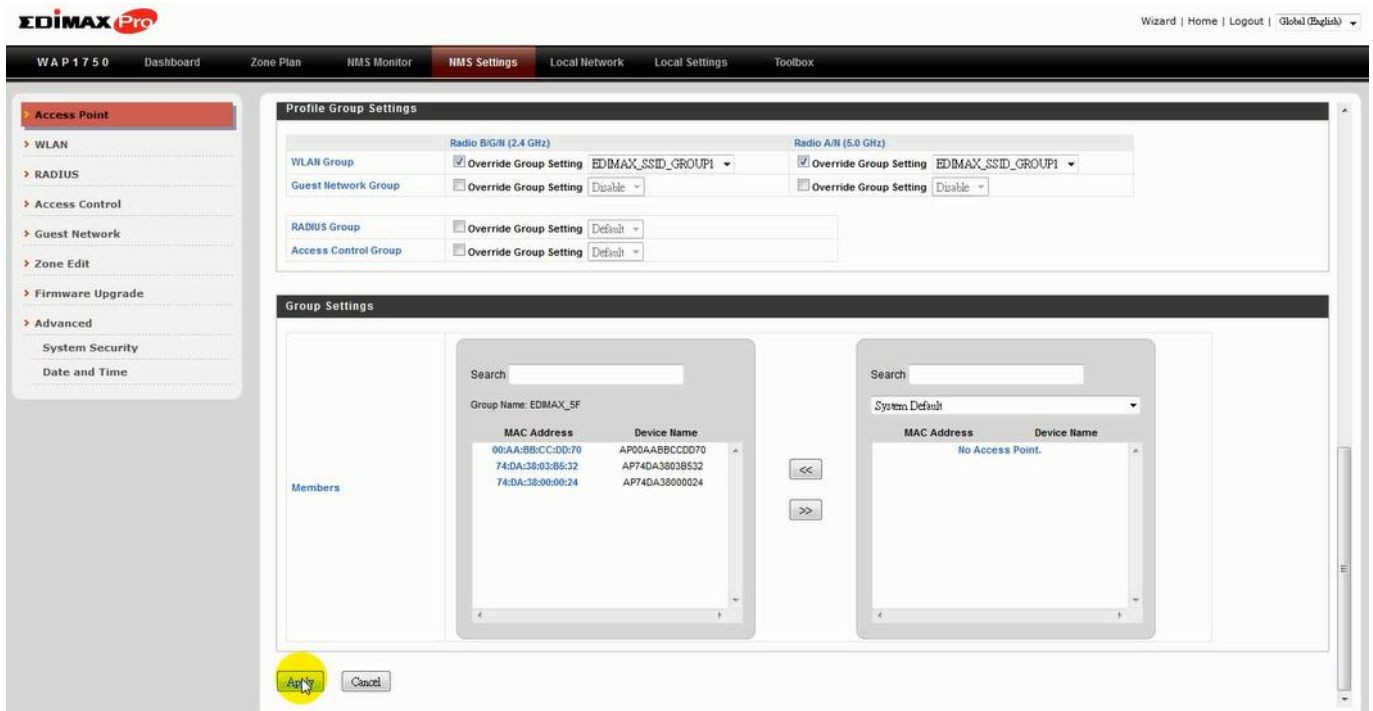

3. Repeat for other access point groups according to your preference.

COPYRIGHT

Copyright © Edimax Technology Co., Ltd. all rights reserved. No part of this publication may be reproduced, transmitted, transcribed, stored in a retrieval system, or translated into any language or computer language, in any form or by any means, electronic, mechanical, magnetic, optical, chemical, manual or otherwise, without the prior written permission from Edimax Technology Co., Ltd.

Edimax Technology Co., Ltd. makes no representations or warranties, either expressed or implied, with respect to the contents hereof and specifically disclaims any warranties, merchantability, or fitness for any particular purpose. Any software described in this manual is sold or licensed as is. Should the programs prove defective following their purchase, the buyer (and not this company, its distributor, or its dealer) assumes the entire cost of all necessary servicing, repair, and any incidental or consequential damages resulting from any defect in the software. Edimax Technology Co., Ltd. reserves the right to revise this publication and to make changes from time to time in the contents hereof without the obligation to notify any person of such revision or changes.

The product you have purchased and the setup screen may appear slightly different from those shown in this QIG. The software and specifications are subject to change without notice. Please visit our website www.edimax.com for updates. All brand and product names mentioned in this manual are trademarks and/or registered trademarks of their respective holders.

Federal Communication Commission Interference Statement

This equipment has been tested and found to comply with the limits for a Class B digital device, pursuant to Part 15 of FCC Rules. These limits are designed to provide reasonable protection against harmful interference in a residential installation. This equipment generates, uses, and can radiate radio frequency energy and, if not installed and used in accordance with the instructions, may cause harmful interference to radio communications. However, there is no guarantee that interference will not occur in a particular installation. If this equipment does cause harmful interference to radio or television reception, which can be determined by turning the equipment off and on, the user is encouraged to try to correct the interference by one or more of the following measures:

1. Reorient or relocate the receiving antenna.
2. Increase the separation between the equipment and receiver.
3. Connect the equipment into an outlet on a circuit different from that to which the receiver is connected.
4. Consult the dealer or an experienced radio technician for help.

FCC Caution

This device and its antenna must not be co-located or operating in conjunction with any other antenna or transmitter. This device complies with Part 15 of the FCC Rules. Operation is subject to the following two conditions: (1) this device may not cause harmful interference, and (2) this device must accept any interference received, including interference that may cause undesired operation. Any changes or modifications not expressly approved by the party responsible for compliance could void the authority to operate equipment.

Federal Communications Commission (FCC) Radiation Exposure Statement

This equipment complies with FCC radiation exposure set forth for an uncontrolled environment. In order to avoid the possibility of exceeding the FCC radio frequency exposure limits, human proximity to the antenna shall not be less than 2.5cm (1 inch) during normal operation.

Federal Communications Commission (FCC) RF Exposure Requirements

SAR compliance has been established in the laptop computer(s) configurations with PCMCIA slot on the side near the center, as tested in the application for certification, and can be used in laptop computer(s) with substantially similar physical dimensions, construction, and electrical and RF characteristics. Use in other devices such as PDAs or lap pads is not authorized. This transmitter is restricted for use with the specific antenna tested in the application for certification. The antenna(s) used for this transmitter must not be co-located or operating in conjunction with any other antenna or transmitter.

R&TTE Compliance Statement

This equipment complies with all the requirements of DIRECTIVE 1999/5/EC OF THE EUROPEAN PARLIAMENT AND THE COUNCIL of March 9, 1999 on radio equipment and telecommunication terminal equipment and the mutual recognition of their conformity (R&TTE). The R&TTE Directive repeals and replaces in the directive 98/13/EEC (Telecommunications Terminal Equipment and Satellite Earth Station Equipment) As of April 8, 2000.

Safety

This equipment is designed with the utmost care for the safety of those who install and use it. However, special attention must be paid to the dangers of electric shock and static electricity when working with electrical equipment. All guidelines of this and of the computer manufacture must therefore be allowed at all times to ensure the safe use of the equipment.

EU Countries Intended for Use

The ETSI version of this device is intended for home and office use in Austria, Belgium, Bulgaria, Cyprus, Czech, Denmark, Estonia, Finland, France, Germany, Greece, Hungary, Ireland, Italy, Latvia, Lithuania, Luxembourg, Malta, Netherlands, Poland, Portugal, Romania, Slovakia, Slovenia, Spain, Sweden, Turkey, and United Kingdom. The ETSI version of this device is also authorized for use in EFTA member states: Iceland, Liechtenstein, Norway, and Switzerland.

EU Countries Not Intended for Use

None

EU Declaration of Conformity

- English:** This equipment is in compliance with the essential requirements and other relevant provisions of Directive 1995/5/EC, 2009/125/EC, 2006/95/EC, 2011/65/EC.
- Français:** Cet équipement est conforme aux exigences essentielles et autres dispositions de la directive 1995/5/CE, 2009/125/CE, 2006/95/CE, 2011/65/CE.
- Čeština:** Toto zařízení je v souladu se základními požadavky a ostatními příslušnými ustanoveními směrnic 1995/5/ES, 2009/125/ES, 2006/95/ES, 2011/65/ES.
- Polški:** Urządzenie jest zgodne z ogólnymi wymaganiami oraz szczególnymi warunkami określonymi Dyrektywą UE 1995/5/EC, 2009/125/EC, 2006/95/EC, 2011/65/EC..
- Română:** Acest echipament este în conformitate cu cerințele esențiale și alte prevederi relevante ale Directivei 1995/5/CE, 2009/125/CE, 2006/95/CE, 2011/65/CE.
- Русский:** Это оборудование соответствует основным требованиям и положениям Директивы 1995/5/EC, 2009/125/EC, 2006/95/EC, 2011/65/EC.
- Magyar:** Ez a berendezés megfelel az alapvető követelményeknek és más vonatkozó irányelveknek (1995/5/EK, 2009/125/EK, 2006/95/EK, 2011/65/EK).
- Türkçe:** Bu cihaz 1995/5/EC, 2009/125/EC, 2006/95/EC, 2011/65/EC direktifleri zorunlu istekler ve diğer hükümlerle ile uyumludur.
- Українська:** Обладнання відповідає вимогам і умовам директиви 1995/5/EC, 2009/125/EC, 2006/95/EC, 2011/65/EC.
- Slovenčina:** Toto zariadenie spĺňa základné požiadavky a ďalšie príslušné ustanovenia smerníc 1995/5/ES, 2009/125/ES, 2006/95/ES, 2011/65/ES.
- Deutsch:** Dieses Gerät erfüllt die Voraussetzungen gemäß den Richtlinien 1995/5/EC, 2009/125/EC, 2006/95/EC, 2011/65/EC.
- Español:** El presente equipo cumple los requisitos esenciales de la Directiva 1995/5/EC, 2009/125/EC, 2006/95/EC, 2011/65/EC.
- Italiano:** Questo apparecchio è conforme ai requisiti essenziali e alle altre disposizioni applicabili della Direttiva 1995/5/CE, 2009/125/CE, 2006/95/CE, 2011/65/CE.
- Nederlands:** Dit apparaat voldoet aan de essentiële eisen en andere van toepassing zijnde bepalingen van richtlijn 1995/5/EC, 2009/125/EC, 2006/95/EC, 2011/65/EC..
- Português:** Este equipamento cumpre os requisitos essenciais da Directiva 1995/5/EC, 2009/125/EC, 2006/95/EC, 2011/65/EC.
- Norsk:** Dette utstyret er i samsvar med de viktigste kravene og andre relevante regler i Direktiv 1995/5/EC, 2009/125/EC, 2006/95/EC, 2011/65/EC.
- Svenska:** Denna utrustning är i överensstämmelse med de väsentliga kraven och övriga relevanta bestämmelser i direktiv 1995/5/EG, 2009/125/EG, 2006/95/EG, 2011/65/EG.
- Dansk:** Dette udstyr er i overensstemmelse med de væsentligste krav og andre relevante forordninger i direktiv 1995/5/EC, 2009/125/EC, 2006/95/EC, 2011/65/EC.
- suomen kieli:** Tämä laite täyttää direktiivien 1995/5/EY, 2009/125/EY, 2006/95/EY, 2011/65/EY oleelliset vaatimukset ja muut asiaankuuluvat määräykset.

FOR USE IN 



WEEE Directive & Product Disposal



At the end of its serviceable life, this product should not be treated as household or general waste. It should be handed over to the applicable collection point for the recycling of electrical and electronic equipment, or returned to the supplier for disposal.

Declaration of Conformity

We, Edimax Technology Co., Ltd., declare under our sole responsibility, that the equipment described below complies with the requirements of the European R&TTE directives.

Equipment: AC1200 Ceiling Mount Access Point
Model No.: CAP1200

The following European standards for essential requirements have been followed:

Directives 1999/5/EC

Spectrum : ETSI EN 300 328 V1.8.1 (2012-06);
EMC : EN 301 489-1 V1.9.2 (2011-09);
EN 301 489-17 V2.2.1 (2012-09);
Safety (LVD) : IEC 60950-1:2005 (2nd Edition);Am 1:2009+Am2:2013
EN 60950-1:2006+A11+A:2010+A12:20+A2:2013

Recommendation 1999/5/EC

EMF : EN 62311:2008

Directives 2006/95/EC; 2014/35/EU

Safety (LVD) : IEC 60950-1:2005 (2nd Edition);Am 1:2009+Am2:2013
EN 60950-1:2006+A11+A:2010+A12:20+A2:2013

Edimax Technology Co., Ltd.
No. 3, Wu Chuan 3rd Road,
Wu-Ku Industrial Park,
New Taipei City, Taiwan



Date of Signature: Jan, 2015

Signature:

Printed Name:

Albert Chang

Title:

Director

Edimax Technology Co., Ltd.

Notice According to GNU General Public License Version 2

This product includes software that is subject to the GNU General Public License version 2. The program is free software and distributed without any warranty of the author. We offer, valid for at least three years, to give you, for a charge no more than the costs of physically performing source distribution, a complete machine-readable copy of the corresponding source code.

Das Produkt beinhaltet Software, die den Bedingungen der GNU/GPL-Version 2 unterliegt. Das Programm ist eine sog. „Free Software“, der Autor stellt das Programm ohne irgendeine Gewährleistungen zur Verfügung. Wir bieten Ihnen für einen Zeitraum von drei Jahren an, eine vollständige maschinenlesbare Kopie des Quelltextes der Programme zur Verfügung zu stellen – zu nicht höheren Kosten als denen, die durch den physikalischen Kopiervorgang anfallen.

GNU GENERAL PUBLIC LICENSE

Version 2, June 1991

Copyright (C) 1989, 1991 Free Software Foundation, Inc. 51 Franklin Street, Fifth Floor, Boston, MA 02110-1301, USA
Everyone is permitted to copy and distribute verbatim copies of this license document, but changing it is not allowed.

Preamble

The licenses for most software are designed to take away your freedom to share and change it. By contrast, the GNU General Public License is intended to guarantee your freedom to share and change free software--to make sure the software is free for all its users. This General Public License applies to most of the Free Software Foundation's software and to any other program whose authors commit to using it. (Some other Free Software Foundation software is covered by the GNU Lesser General Public License instead.) You can apply it to your programs, too.

When we speak of free software, we are referring to freedom, not price. Our General Public Licenses are designed to make sure that you have the freedom to distribute copies of free software (and charge for this service if you wish), that you receive source code or can get it if you want it, that you can change the software or use pieces of it in new free programs; and that you know you can do these things.

To protect your rights, we need to make restrictions that forbid anyone to deny you these rights or to ask you to surrender the rights. These restrictions translate to certain responsibilities for you if you distribute copies of the software, or if you modify it.

For example, if you distribute copies of such a program, whether gratis or for a fee, you must give the recipients all the rights that you have. You must make sure that they, too, receive or can get the source code. And you must show them these terms so they know their rights.

We protect your rights with two steps: (1) copyright the software, and (2) offer you this license which gives you legal permission to copy, distribute and/or modify the software.

Also, for each author's protection and ours, we want to make certain that everyone understands that there is no warranty for this free software. If the software is modified by someone else and passed on, we want its recipients to know that what they have is not the original, so that any problems introduced by others will not reflect on the original authors' reputations.

Finally, any free program is threatened constantly by software patents. We wish to avoid the danger that redistributors of a free program will individually obtain patent licenses, in effect making the program proprietary. To prevent this, we have made it clear that any patent must be licensed for everyone's free use or not licensed at all.

The precise terms and conditions for copying, distribution and modification follow.

TERMS AND CONDITIONS FOR COPYING, DISTRIBUTION AND MODIFICATION

0. This License applies to any program or other work which contains a notice placed by the copyright holder saying it may be distributed under the terms of this General Public License. The "Program", below, refers to any such program or work, and a "work based on the Program" means either the Program or any derivative work under copyright law: that is to say, a work containing the Program or a portion of it, either verbatim or with modifications and/or translated into another language. (Hereinafter, translation is included without limitation in the term "modification".) Each licensee is addressed as "you".

Activities other than copying, distribution and modification are not covered by this License; they are outside its scope. The act of running the Program is not restricted, and the output from the Program is covered only if its contents constitute a work based on the Program (independent of having been made by running the Program). Whether that is true depends on what the Program does.

1. You may copy and distribute verbatim copies of the Program's source code as you receive it, in any medium, provided that you conspicuously and appropriately publish on each copy an appropriate copyright notice and disclaimer of warranty; keep intact all the notices that refer to this License and to the absence of any warranty; and give any other recipients of the Program a copy of this License along with the Program.

You may charge a fee for the physical act of transferring a copy, and you may at your option offer warranty protection in exchange for a fee.

2. You may modify your copy or copies of the Program or any portion of it, thus forming a work based on the Program, and copy and distribute such modifications or work under the terms of Section 1 above, provided that you also meet all of these conditions:

- a) You must cause the modified files to carry prominent notices stating that you changed the files and the date of any change.
- b) You must cause any work that you distribute or publish, that in whole or in part contains or is derived from the Program or any part thereof, to be licensed as a whole at no charge to all third parties under the terms of this License.
- c) If the modified program normally reads commands interactively when run, you must cause it, when started running for such interactive use in the most ordinary way, to print or display an announcement including an appropriate copyright notice and a notice that there is no warranty (or else, saying that you provide a warranty) and that users may redistribute the program under these conditions, and telling the user how to view a copy of this License. (Exception: if the Program itself is interactive but does not normally print such an announcement, your work based on the Program is not required to print an announcement.)

These requirements apply to the modified work as a whole. If identifiable sections of that work are not derived from the Program, and can be reasonably considered independent and separate works in themselves, then this License, and its terms, do not apply to those sections when you distribute them as separate works. But when you distribute the same sections as part of a whole which is a work based on the Program, the distribution of the whole must be on the terms of this License, whose permissions for other licensees extend to the entire whole, and thus to each and every part regardless of who wrote it.

Thus, it is not the intent of this section to claim rights or contest your rights to work written entirely by you; rather, the intent is to exercise the right to control the distribution of derivative or collective works based on the Program.

In addition, mere aggregation of another work not based on the Program with the Program (or with a work based on the Program) on a volume of a storage or distribution medium does not bring the other work under the scope of this License.

3. You may copy and distribute the Program (or a work based on it, under Section 2) in object code or executable form under the terms of Sections 1 and 2 above provided that you also do one of the following:

- a) Accompany it with the complete corresponding machine-readable source code, which must be distributed under the terms of Sections 1 and 2 above on a medium customarily used for software interchange; or,
- b) Accompany it with a written offer, valid for at least three years, to give any third party, for a charge no more than your cost of physically performing source distribution, a complete machine-readable copy of the corresponding source code, to be distributed under the terms of Sections 1 and 2 above on a medium customarily used for software interchange; or,
- c) Accompany it with the information you received as to the offer to distribute corresponding source code. (This alternative is allowed only for noncommercial distribution and only if you received the program in object code or executable form with such an offer, in accord with Subsection b above.)

The source code for a work means the preferred form of the work for making modifications to it. For an executable work, complete source code means all the source code for all modules it contains, plus any associated interface definition files, plus the scripts used to control compilation and installation of the executable. However, as a special exception, the source code distributed need not include anything that is normally distributed (in either source or binary form) with the major components (compiler, kernel, and so on) of the operating system on which the executable runs, unless that component itself accompanies the executable.

If distribution of executable or object code is made by offering access to copy from a designated place, then offering equivalent access to copy the source code from the same place counts as distribution of the source code, even though third parties are not compelled to copy the source along with the object code.

4. You may not copy, modify, sublicense, or distribute the Program except as expressly provided under this License. Any attempt otherwise to copy, modify, sublicense or distribute the Program is void, and will automatically terminate your rights under this License. However, parties who have received copies, or rights, from you under this License will not have their licenses terminated so long as such parties remain in full compliance.

5. You are not required to accept this License, since you have not signed it. However, nothing else grants you permission to modify or distribute the Program or its derivative works. These actions are prohibited by law if you do not accept this License. Therefore, by modifying or distributing the Program (or any work based on the Program), you indicate your acceptance of this License to do so, and all its terms and conditions for copying, distributing or modifying the Program or works based on it.

6. Each time you redistribute the Program (or any work based on the Program), the recipient automatically receives a license from the original licensor to copy, distribute or modify the Program subject to these terms and conditions. You may not impose any further restrictions on the recipients' exercise of the rights granted herein. You are not responsible for enforcing compliance by third parties to this License.

7. If, as a consequence of a court judgment or allegation of patent infringement or for any other reason (not limited to patent issues), conditions are imposed on you (whether by court order, agreement or otherwise) that contradict the conditions of this License, they do not excuse you from the conditions of this License. If you cannot distribute so as to satisfy simultaneously your obligations under this License and any other pertinent obligations, then as a consequence you may not distribute the Program at all. For example, if a patent license would not permit royalty-free redistribution of the Program by all those who receive copies directly or indirectly through you, then the only way you could satisfy both it and this License would be to refrain entirely from distribution of the Program.

If any portion of this section is held invalid or unenforceable under any particular circumstance, the balance of the section is intended to apply and the section as a whole is intended to apply in other circumstances.

It is not the purpose of this section to induce you to infringe any patents or other property right claims or to contest validity of any such claims; this section has the sole purpose of protecting the integrity of the free software distribution system, which is implemented by public license practices. Many people have made generous contributions to the wide range of software distributed through that system in reliance on consistent application of that system; it is up to the author/donor to decide if he or she is willing to distribute software through any other system and a licensee cannot impose that choice.

This section is intended to make thoroughly clear what is believed to be a consequence of the rest of this License.

8. If the distribution and/or use of the Program is restricted in certain countries either by patents or by copyrighted interfaces, the original copyright holder who places the Program under this License may add an explicit geographical distribution limitation excluding those countries, so that distribution is permitted only in or among countries not thus excluded. In such case, this License incorporates the limitation as if written in the body of this License.

9. The Free Software Foundation may publish revised and/or new versions of the General Public License from time to time. Such new versions will be similar in spirit to the present version, but may differ in detail to address new problems or concerns.

Each version is given a distinguishing version number. If the Program specifies a version number of this License which applies to it and "any later version", you have the option of following the terms and conditions either of that version or of any later version published by the Free Software Foundation. If the Program does not specify a version number of this License, you may choose any version ever published by the Free Software Foundation.

10. If you wish to incorporate parts of the Program into other free programs whose distribution conditions are different, write to the author to ask for permission. For software which is copyrighted by the Free Software Foundation, write to the Free Software Foundation; we sometimes make exceptions for this. Our decision will be guided by the two goals of preserving the free status of all derivatives of our free software and of promoting the sharing and reuse of software generally.

NO WARRANTY

11. BECAUSE THE PROGRAM IS LICENSED FREE OF CHARGE, THERE IS NO WARRANTY FOR THE PROGRAM, TO THE EXTENT PERMITTED BY APPLICABLE LAW. EXCEPT WHEN OTHERWISE STATED IN WRITING THE COPYRIGHT HOLDERS AND/OR OTHER PARTIES PROVIDE THE PROGRAM "AS IS" WITHOUT WARRANTY OF ANY KIND, EITHER EXPRESSED OR IMPLIED, INCLUDING, BUT NOT LIMITED TO, THE IMPLIED WARRANTIES OF MERCHANTABILITY AND FITNESS FOR A PARTICULAR PURPOSE. THE ENTIRE RISK AS TO THE QUALITY AND PERFORMANCE OF THE PROGRAM IS WITH YOU. SHOULD THE PROGRAM PROVE DEFECTIVE, YOU ASSUME THE COST OF ALL NECESSARY SERVICING, REPAIR OR CORRECTION.

12. IN NO EVENT UNLESS REQUIRED BY APPLICABLE LAW OR AGREED TO IN WRITING WILL ANY COPYRIGHT HOLDER, OR ANY OTHER PARTY WHO MAY MODIFY AND/OR REDISTRIBUTE THE PROGRAM AS PERMITTED ABOVE, BE LIABLE TO YOU FOR DAMAGES, INCLUDING ANY GENERAL, SPECIAL, INCIDENTAL OR CONSEQUENTIAL DAMAGES ARISING OUT OF THE USE OR INABILITY TO USE THE PROGRAM (INCLUDING BUT NOT LIMITED TO LOSS OF DATA OR DATA BEING RENDERED INACCURATE OR LOSSES SUSTAINED BY YOU OR THIRD PARTIES OR A FAILURE OF THE PROGRAM TO OPERATE WITH ANY OTHER PROGRAMS), EVEN IF SUCH HOLDER OR OTHER PARTY HAS BEEN ADVISED OF THE POSSIBILITY OF SUCH DAMAGES.



EDIMAX
NETWORKING PEOPLE TOGETHER